

2J3915M-915

915 MHz ISM Magnetic Mount

Key Features

- 915 MHz ISM
- 902-928 MHz
- Magnetic Mount
- High Performance
- High Gain
- Ground Plane Dependent
- Customizable Cable and Connector
- Dimensions \varnothing 30.9 x 88 mm



1. Antenna and electrical specifications

Parameters	915 MHz ISM Antenna
Standards	ZigBee, ISM, SIGFOX, LoRa
Band (MHz)	915 MHz
Frequency (MHz)	902-928
Return Loss (dB)	~-14.5
VSWR	~1.5:1
Efficiency (%)	~64.6
Peak Gain (dBi)	~3.0
Average Gain (dB)	~-1.9
Impedance (Ohm)	50
Polarisation	Linear
Radiation Pattern	Omni-Directional
Max. Input Power (W)	50
Connector Type	SMA-Male Standard (Other Connectors Available)
Cable Length	300 cm Standard (Any Cable Length Available)
Cable Type	LMR100 Standard (Other Cables Available)

Antenna Measurement Conditions:

Mounted on 30 x 30 cm Metal Plate

200 cm of Cable LMR100

Measured in Certified CTIA 3D Anechoic Chamber

2. Mechanical and environmental specifications

Specifications	2J3915M-915
Mounting Type	Magnetic Mount
Dimensions (mm)	Ø 30.9 × 88
Radome color	Black
Antenna Base	PP
Whip Material	Brass
Operating Temperature (C)	-40 to +85
Storage Temperature (C)	-40 to +85
Substance Compliance	RoHS

3. Antenna parameters

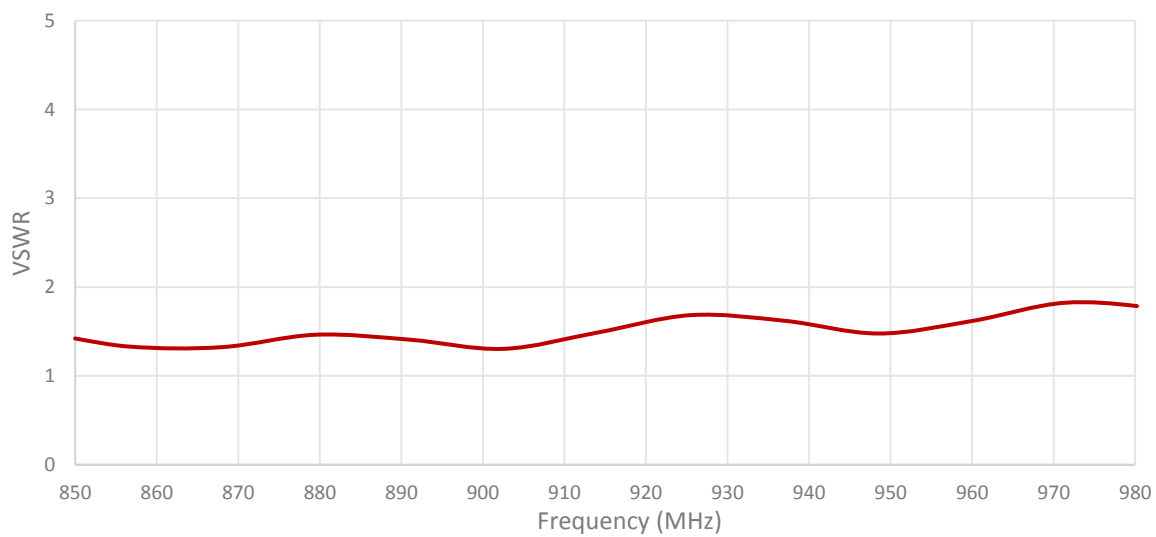
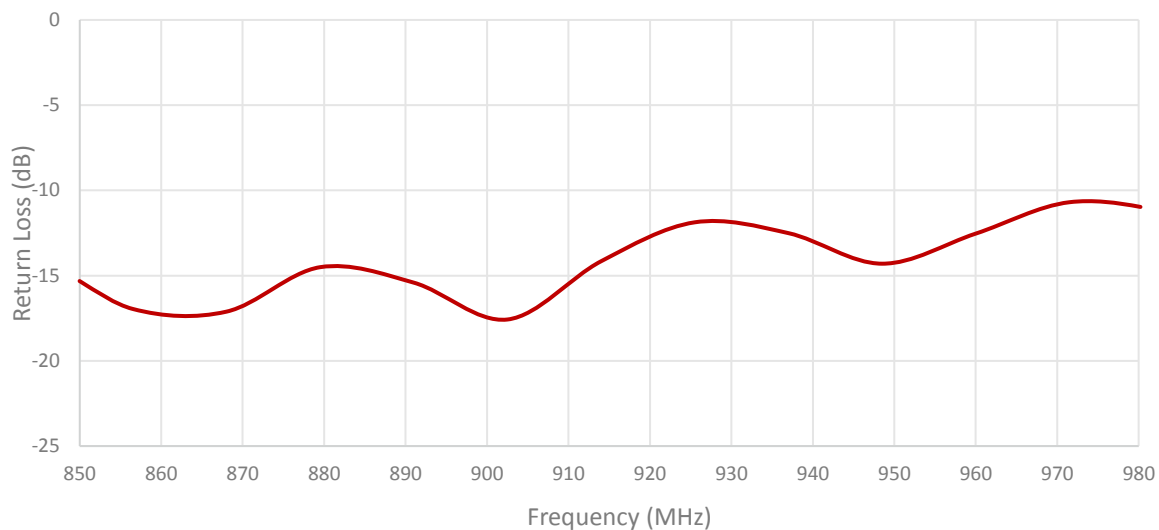

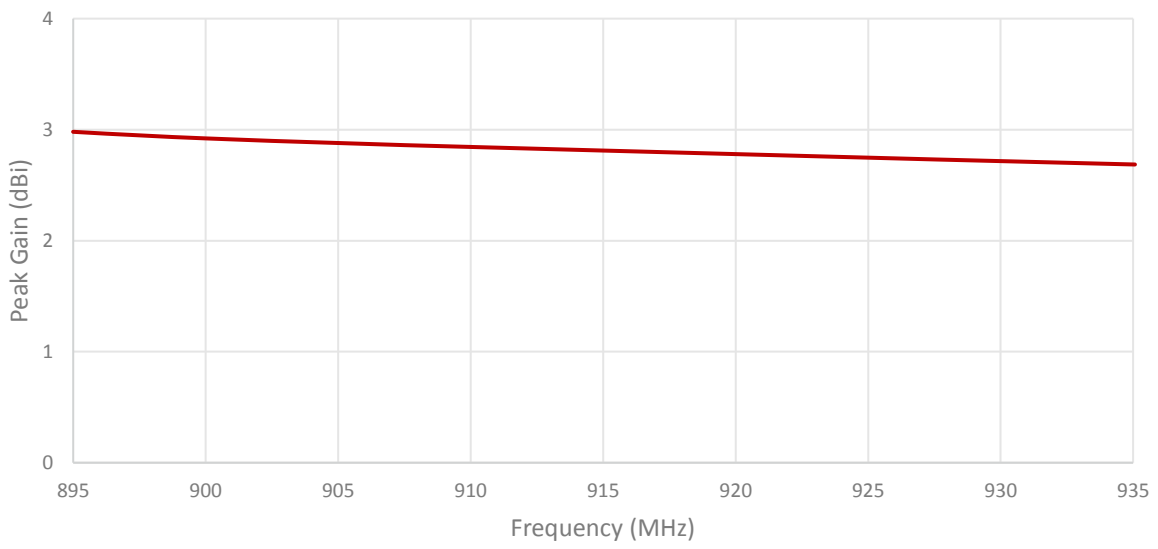
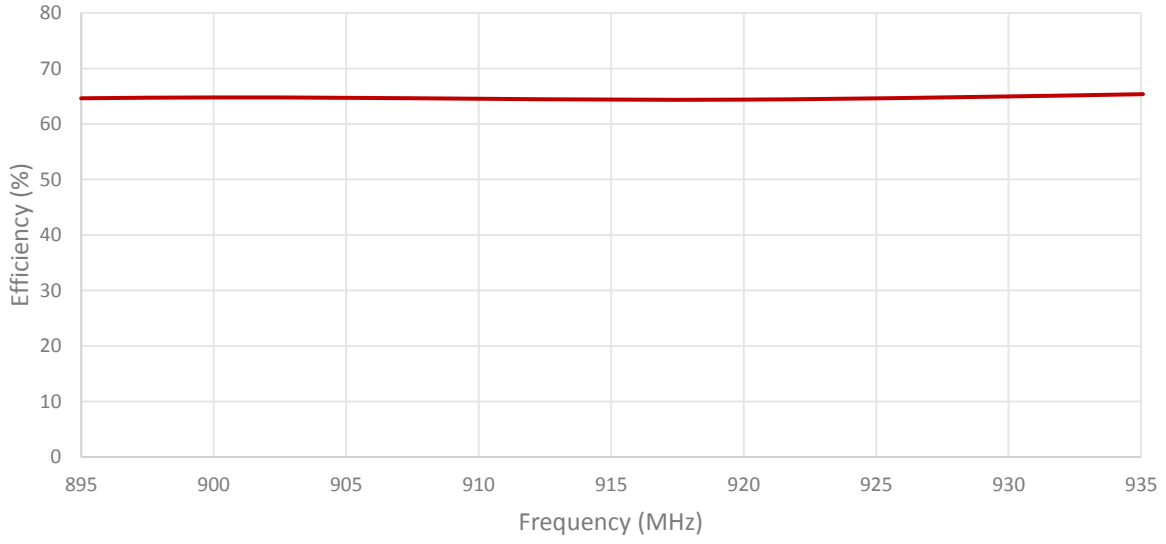

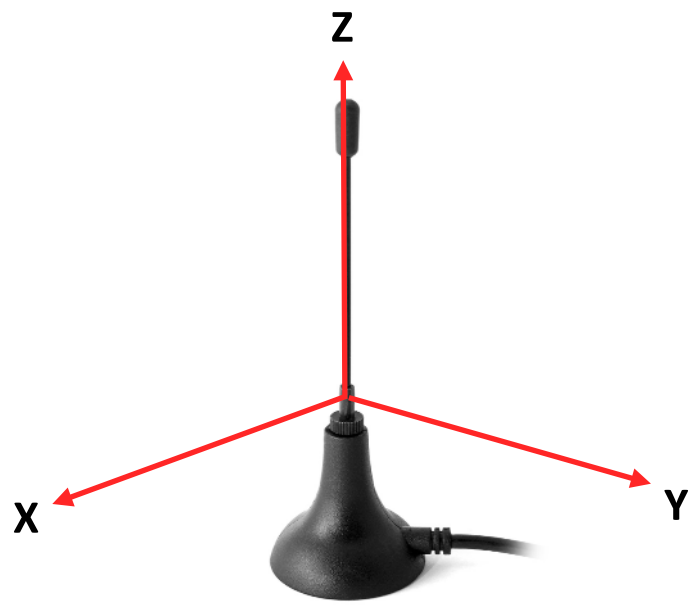
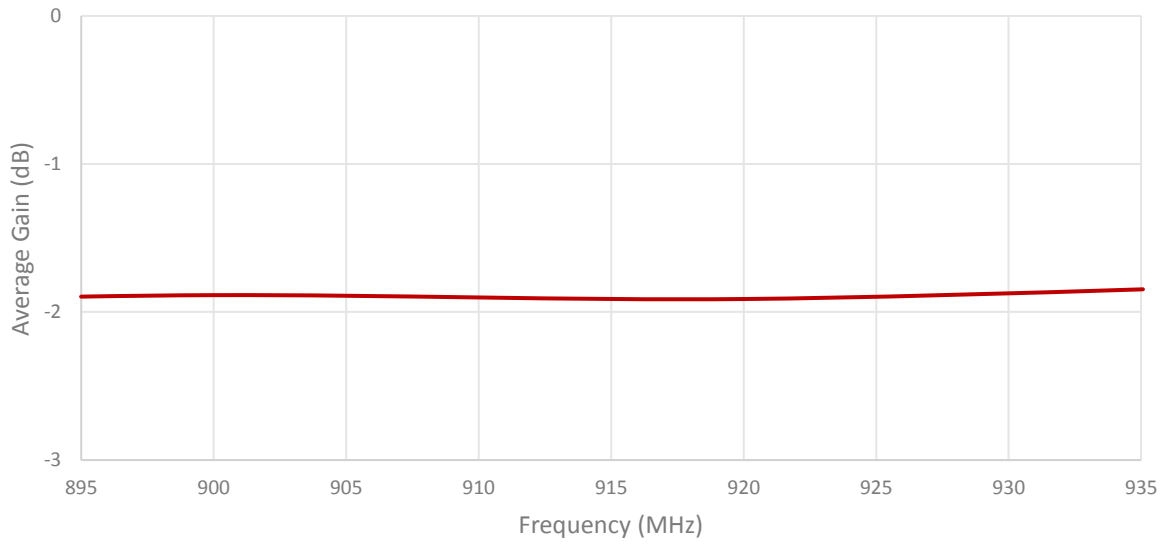

Radiation pattern reference

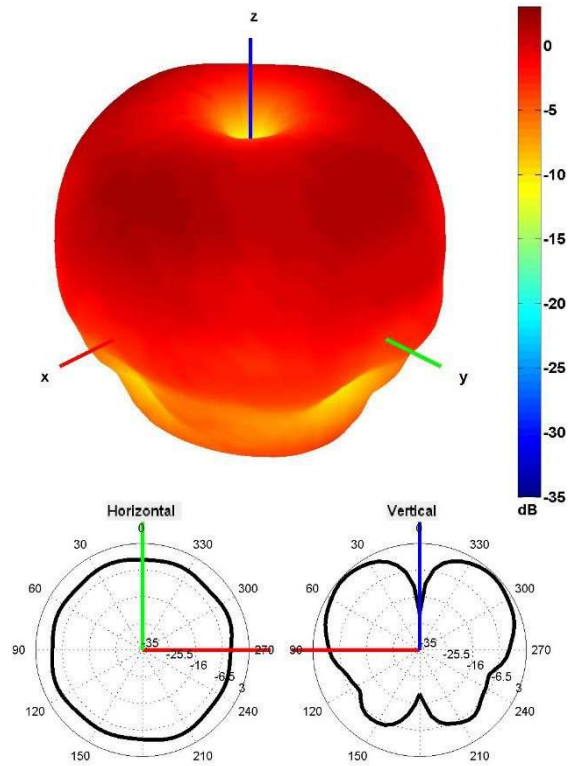

915 MHz Radiation pattern

4. Antenna drawings

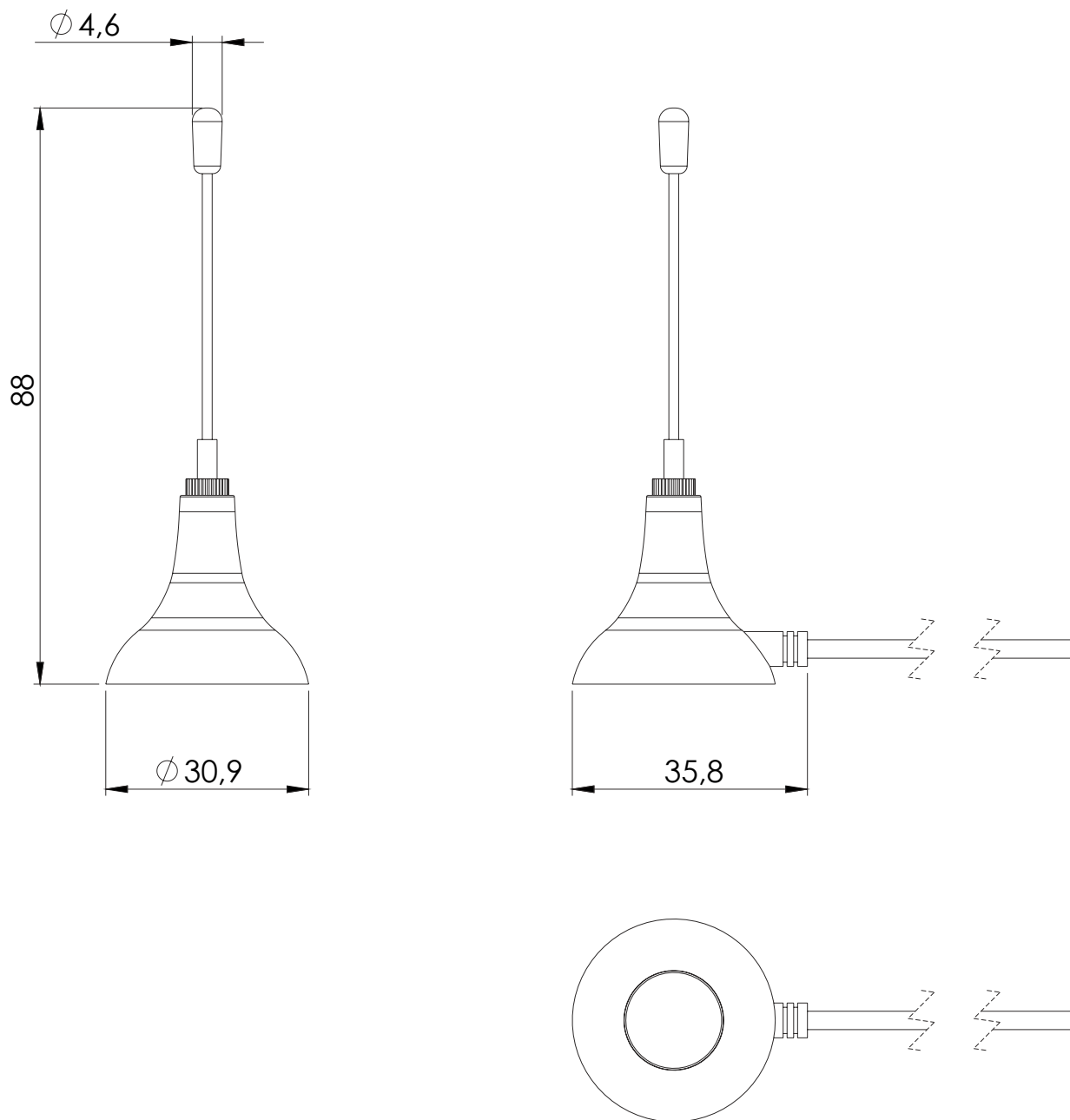

5. Antenna Images

