

2J6002Pa

2.4/5.0 GHz ISM MIMO Adhesive Mount

Key Features

Cable 1 - 2: 2.4/5.0 GHz ISM

- 2410-2490 MHz

- 4920-5925 MHz

Adhesive Mount

Ground Plane Independent

Customizable Cable and Connector

Dimensions: 80 x 76 x 16 mm



1. Antenna and electrical specifications

Cable 1

Parameters	2.4/5.0 GHz ISM Antenna	
Standards	WiFi, BT, ZigBee, ISM	
Band (MHz)	2.4 GHz	5.0 GHz
Frequency (MHz)	2410-2490	4920-5925
Return Loss (dB)	~-16.7	~-14.2
VSWR	~1.4:1	~1.5:1
Efficiency (%)	~61.6	~44.6
Peak Gain (dBi)	~5.0	~4.6
Average Gain (dB)	~-2.1	~-3.5
Impedance (Ohm)	50	
Polarisation	Linear	
Radiation Pattern	Omni-Directional	
Max. Input Power (W)	10	
Connector Type	RP SMA-Male Standard (Other Connectors Available)	
Cable Length	300 cm Standard (Any Cable Length Available)	
Cable Type	DACAR302 (Other Cables Available)	

Cable 2

Parameters	2.4/5.0 GHz ISM Antenna	
Standards	WiFi, BT, ZigBee, ISM	
Band (MHz)	2.4 GHz	5.0 GHz
Frequency (MHz)	2410-2490	4920-5925
Return Loss (dB)	~-17.0	~-16.9
VSWR	~1.4:1	~1.5:1
Efficiency (%)	~60.1	~41.2
Peak Gain (dBi)	~4.8	~5.3
Average Gain (dB)	~-2.2	~-3.9
Impedance (Ohm)	50	
Polarisation	Linear	
Radiation Pattern	Omni-Directional	
Max. Input Power (W)	10	
Connector Type	RP SMA-Male Standard (Other Connectors Available)	
Cable Length	300 cm Standard (Any Cable Length Available)	
Cable Type	DACAR302 (Other Cables Available)	

Antenna Measurement Conditions:

Mounted on 30 x 30 cm Metal Plate

100 cm of DACAR302

Measured in Certified CTIA 3D Anechoic Chamber

2. Mechanical and environmental specifications

Specifications	2J6002Pa
Mounting Type	Adhesive Mount
Dimensions (mm)	80 x 76 x 16
Radome Type	ABS UV Stable
Radome Color	Black or White
Operating Temperature (C)	-40 to +85
Storage Temperature (C)	-40 to +85
Substance Compliance	RoHS

3. Antenna parameters

Cable 1: 2.4/5.0 GHz ISM

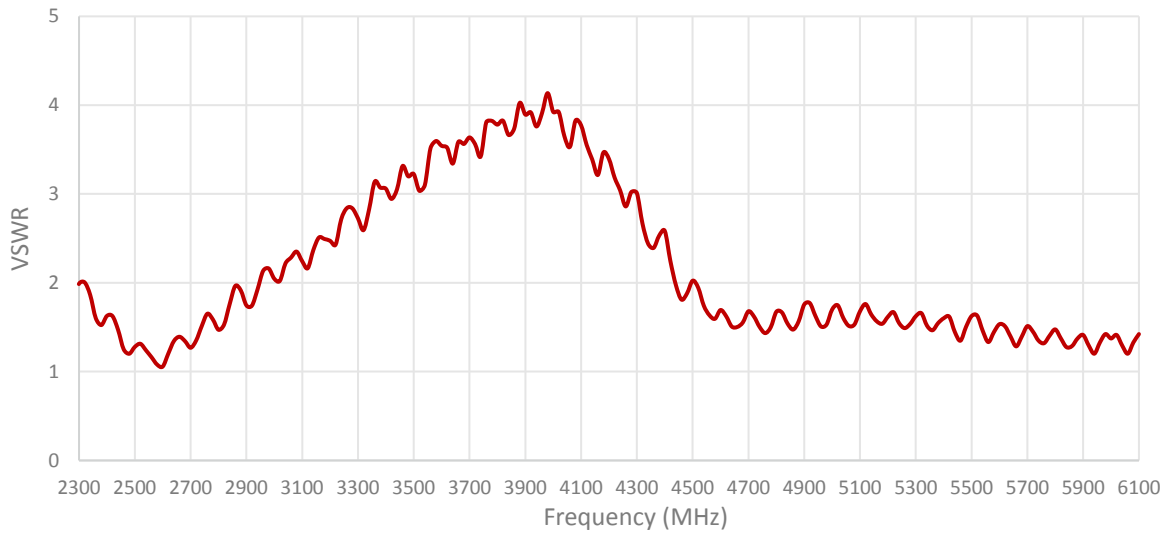
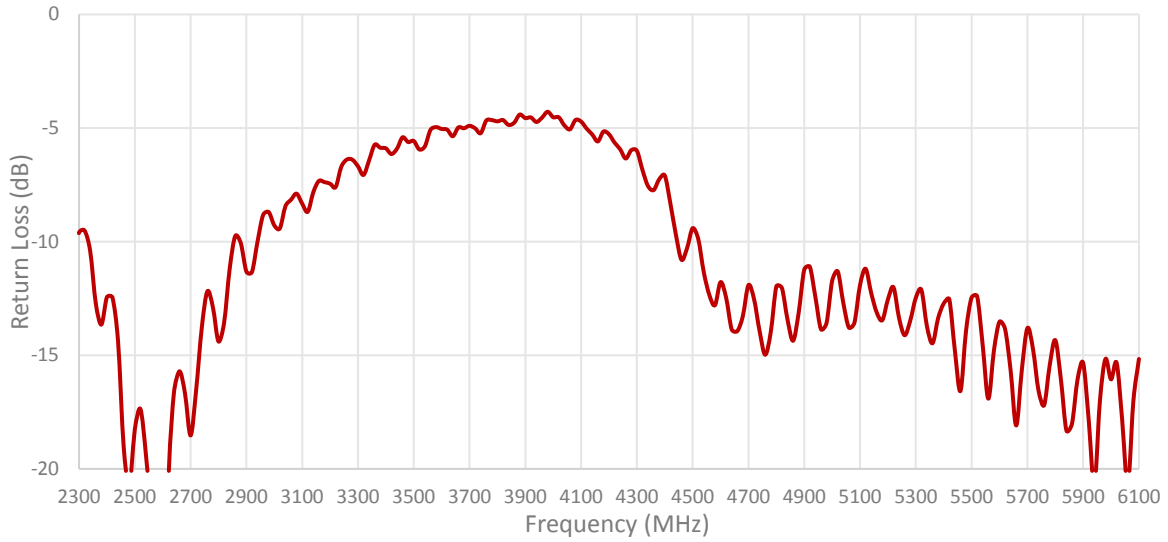

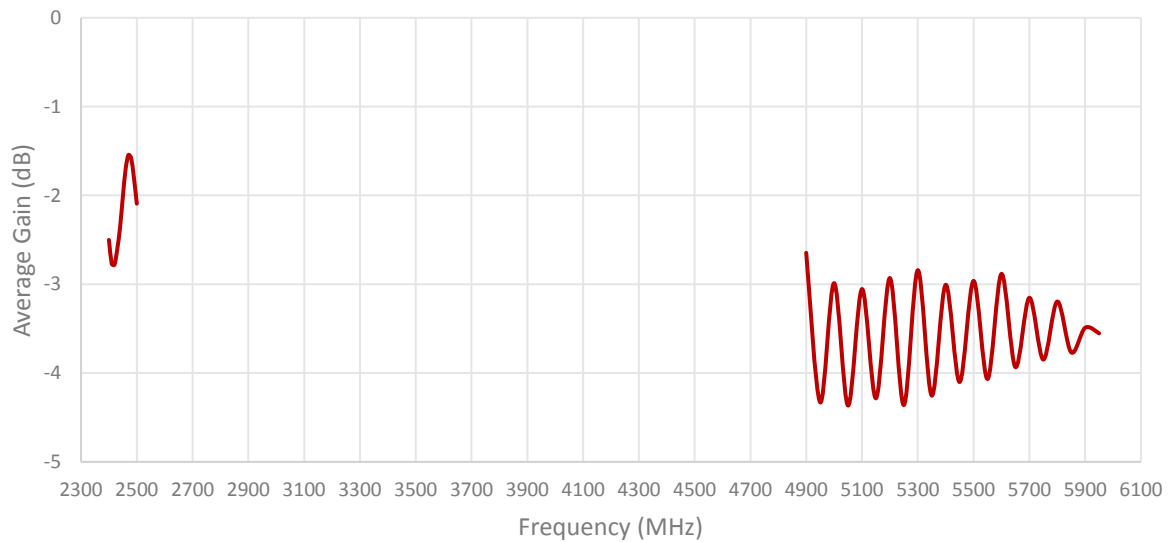
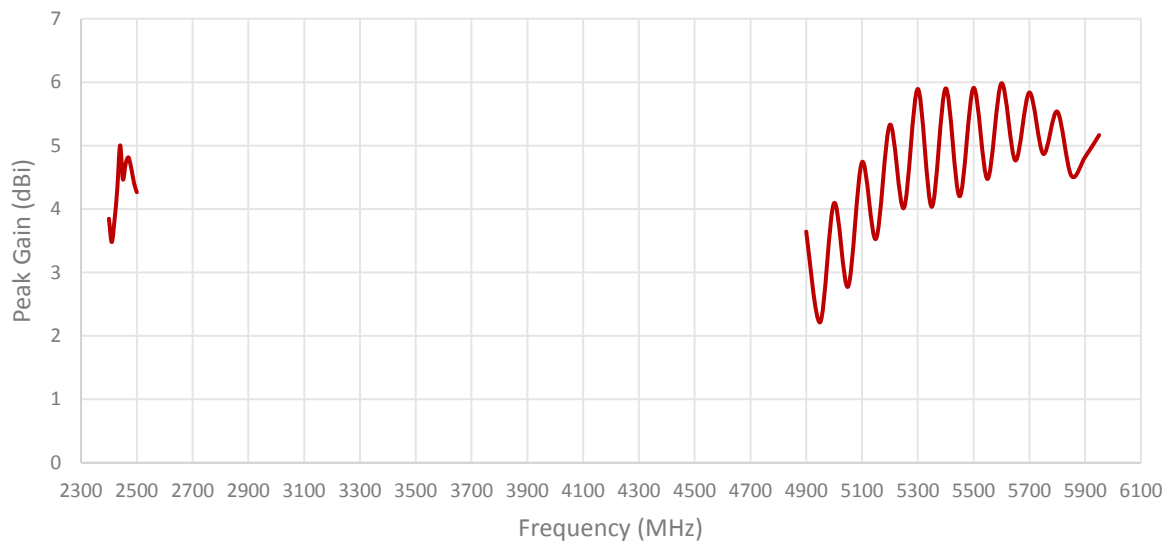
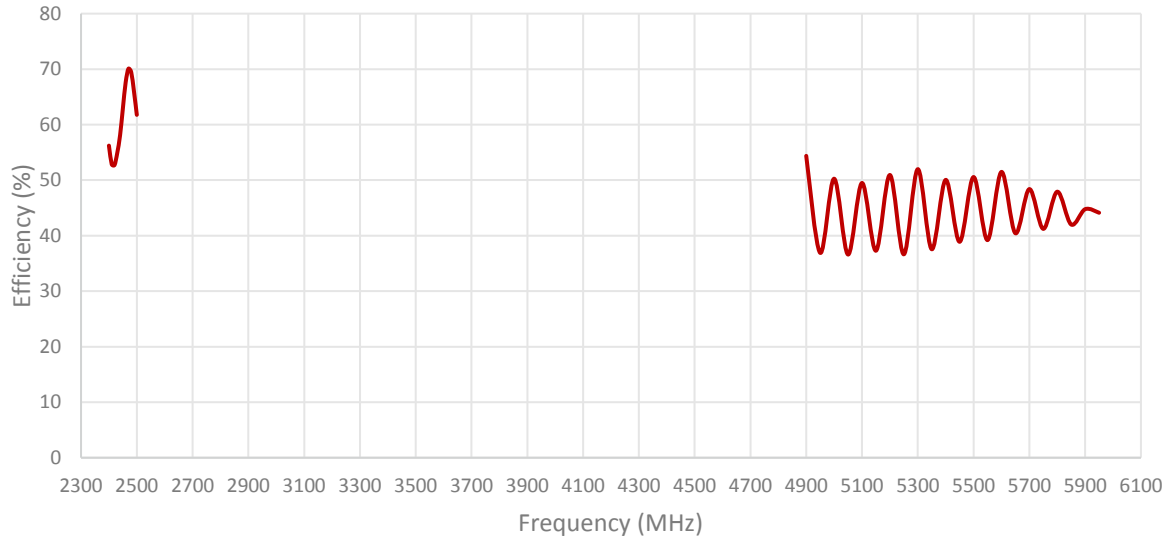
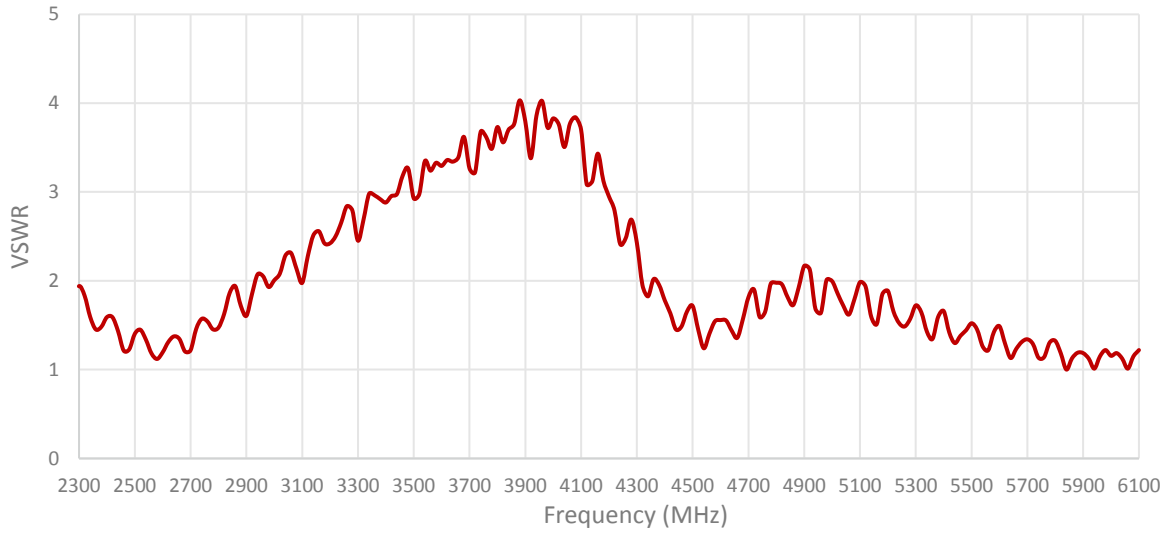
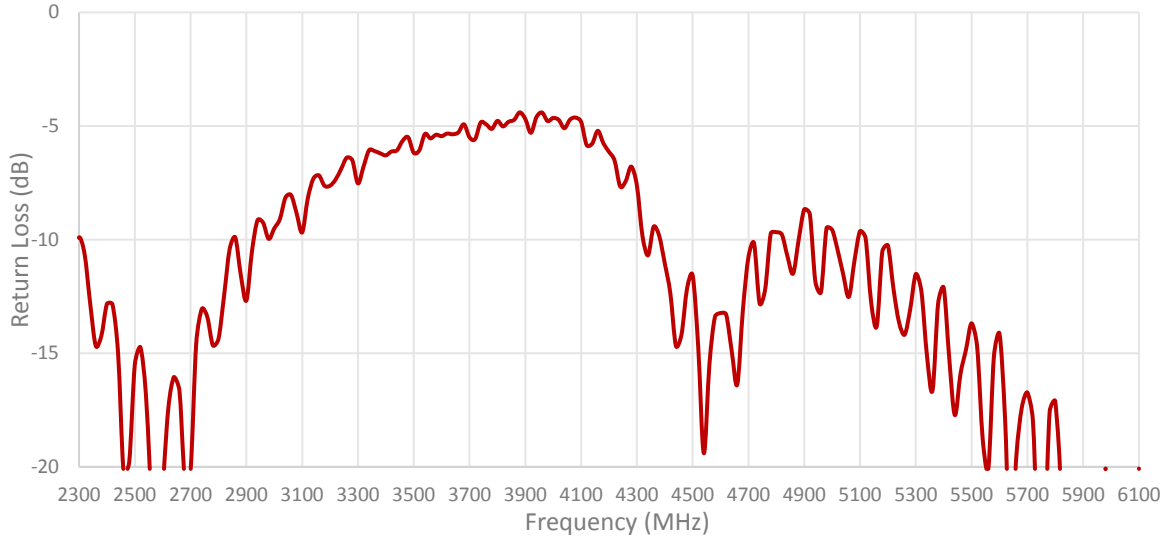
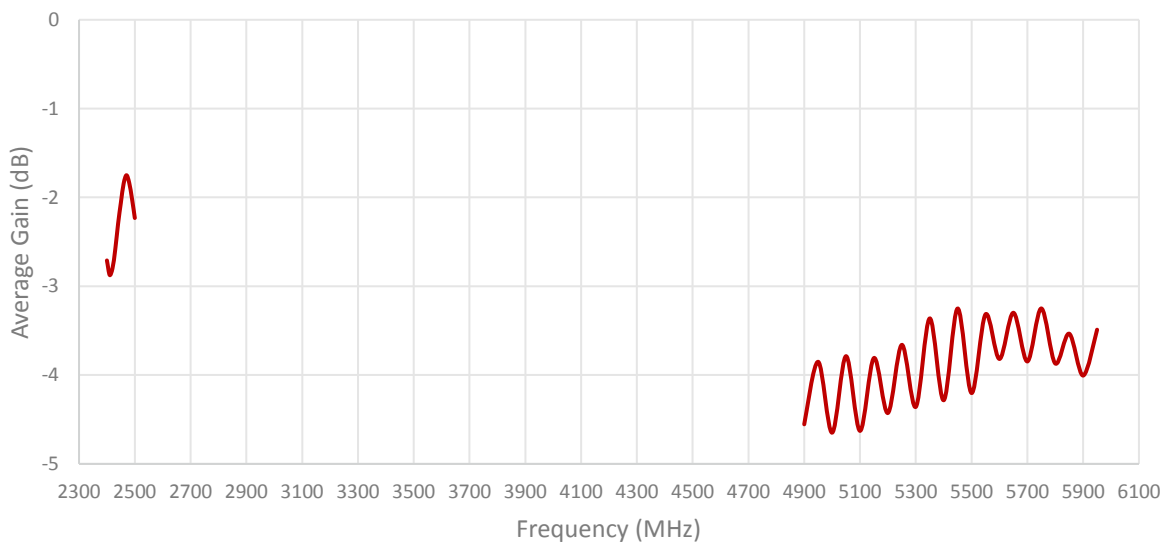
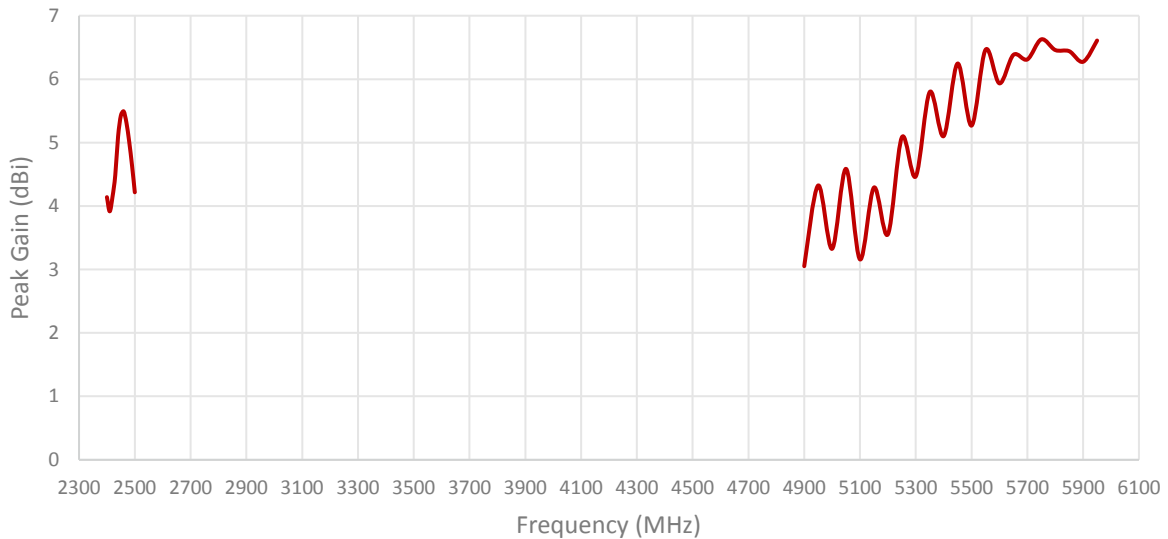
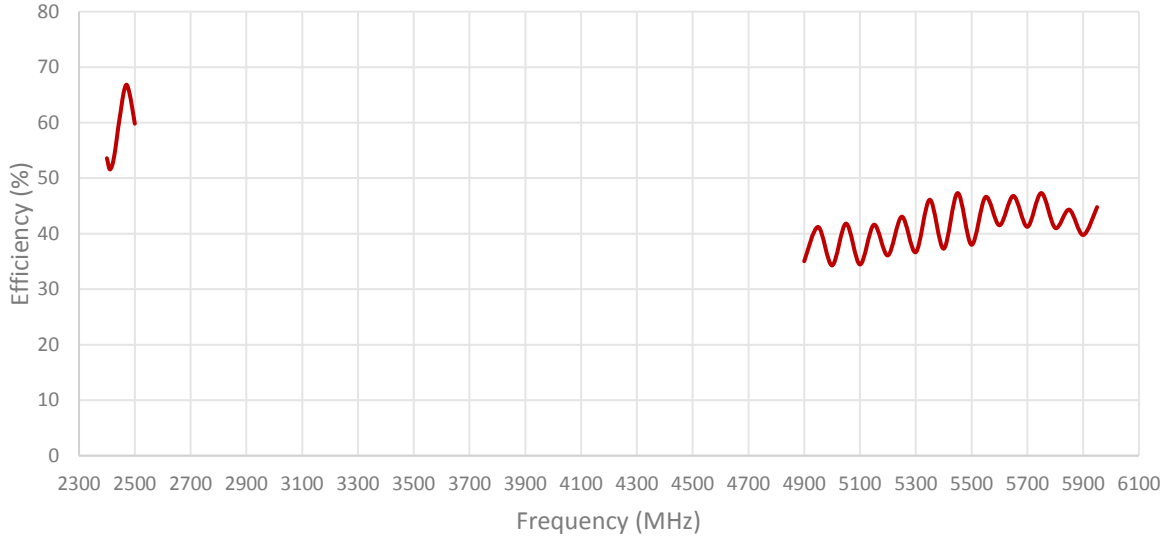
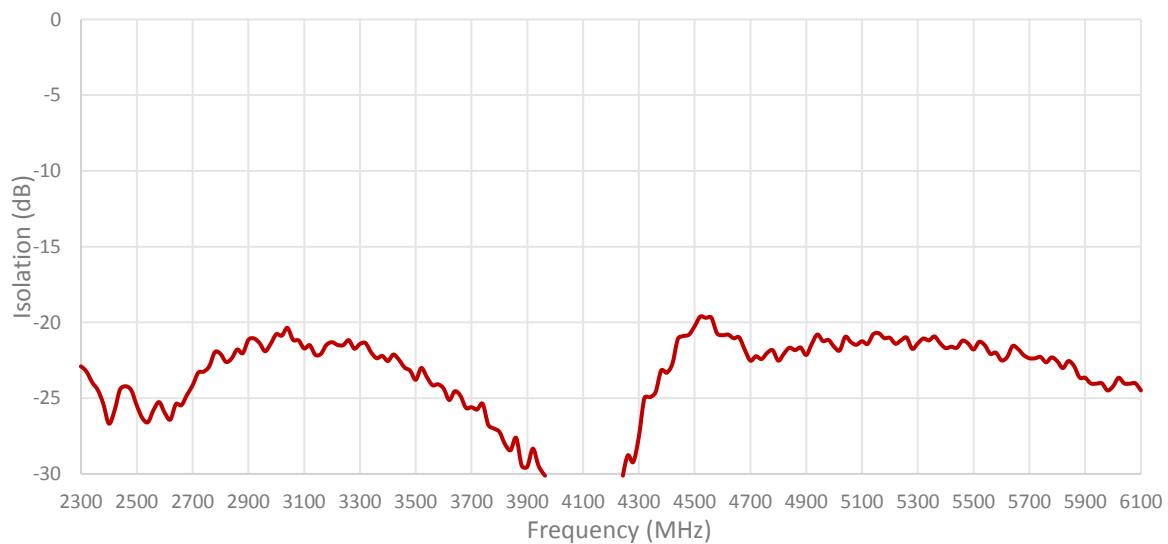

Table 2: 2.4/5.0 GHz ISM





ISOLATION FOR CABLES 1 AND 2



ENVELOPE CORRELATION COEFFICIENT FOR CABLES 1 AND 2

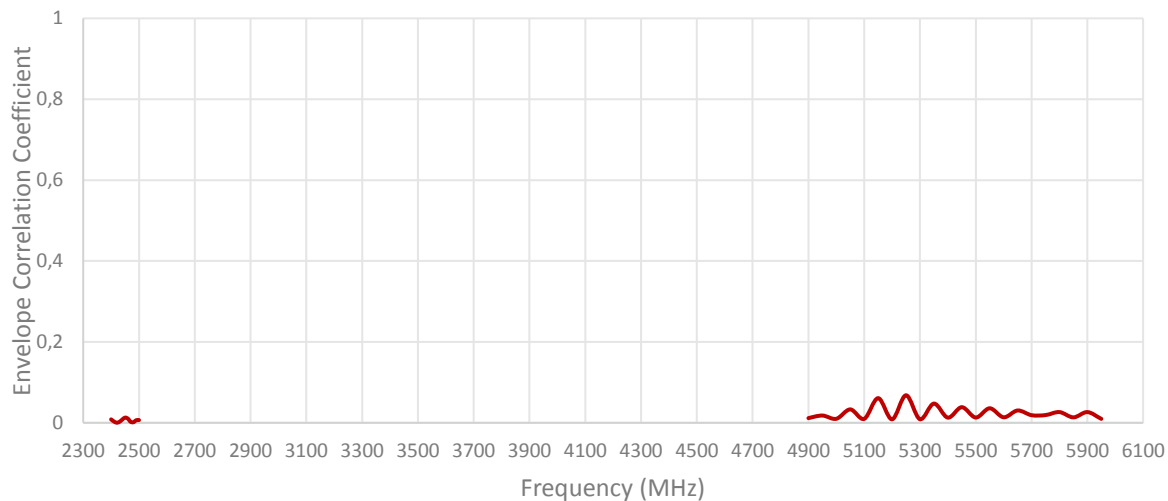

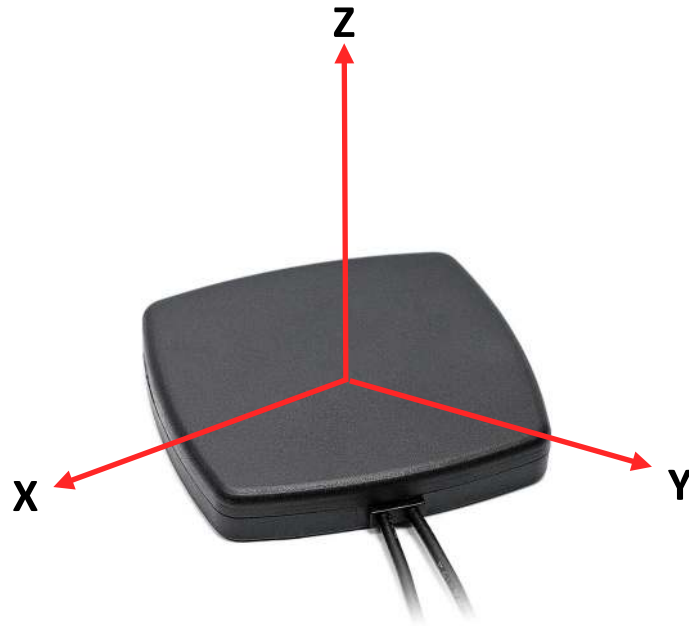

Radiation pattern reference

Cable 1: 2.4/5.0 GHz ISM

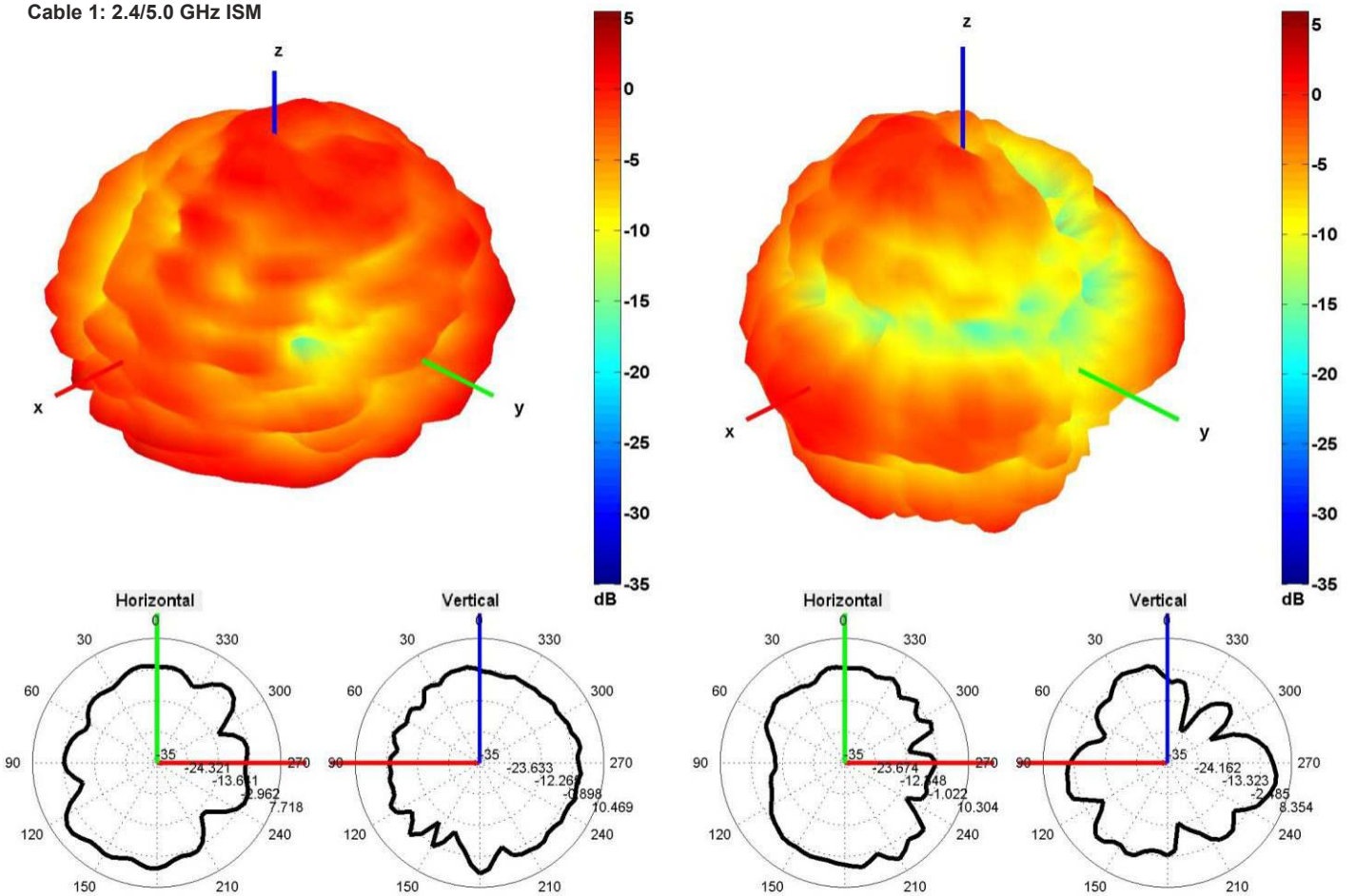

2450 and 5500 MHz Radiation pattern

Cable 2: 2.4/5.0 GHz ISM

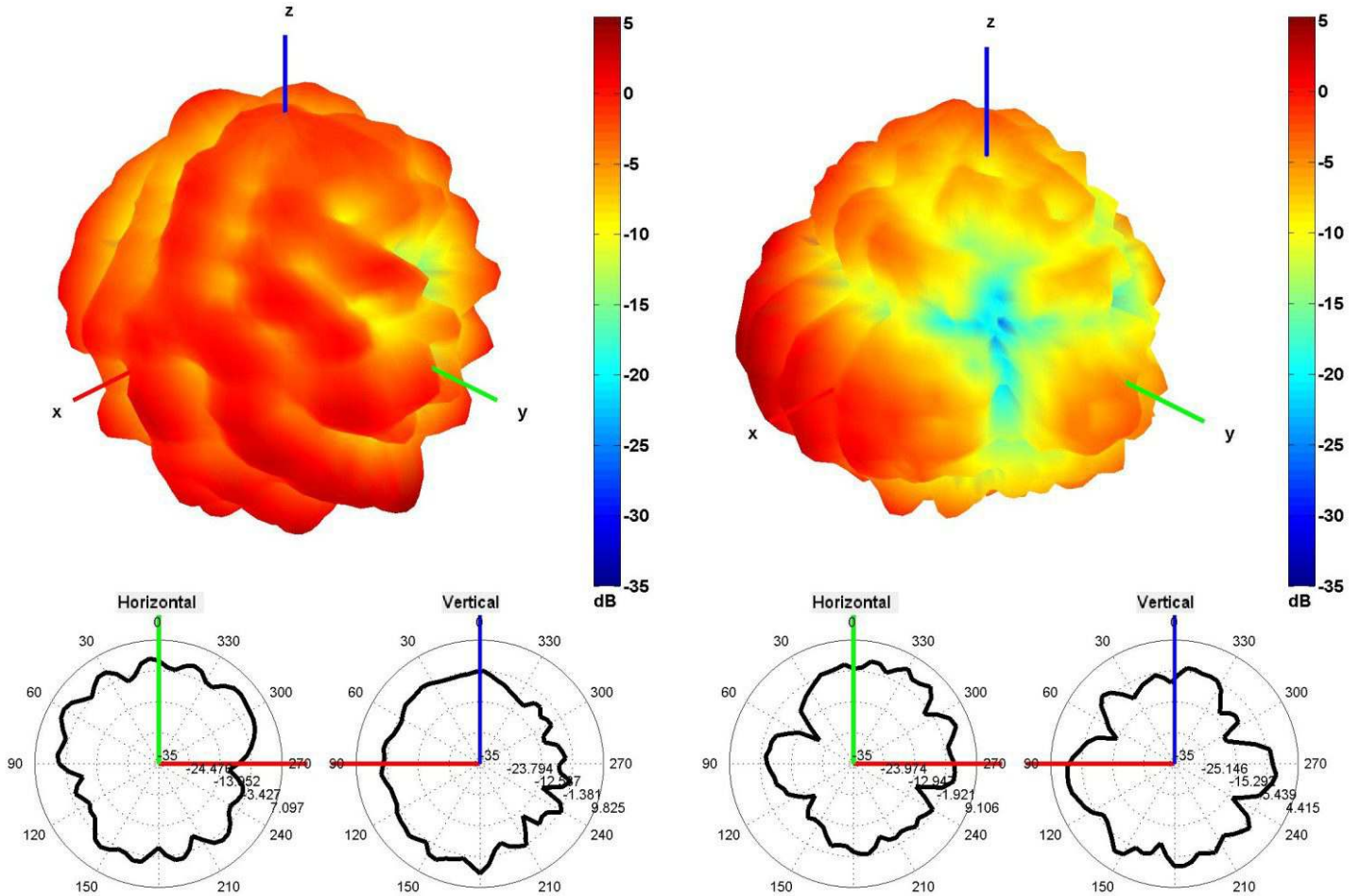

2450 and 5500 MHz Radiation pattern

4. Antenna drawings

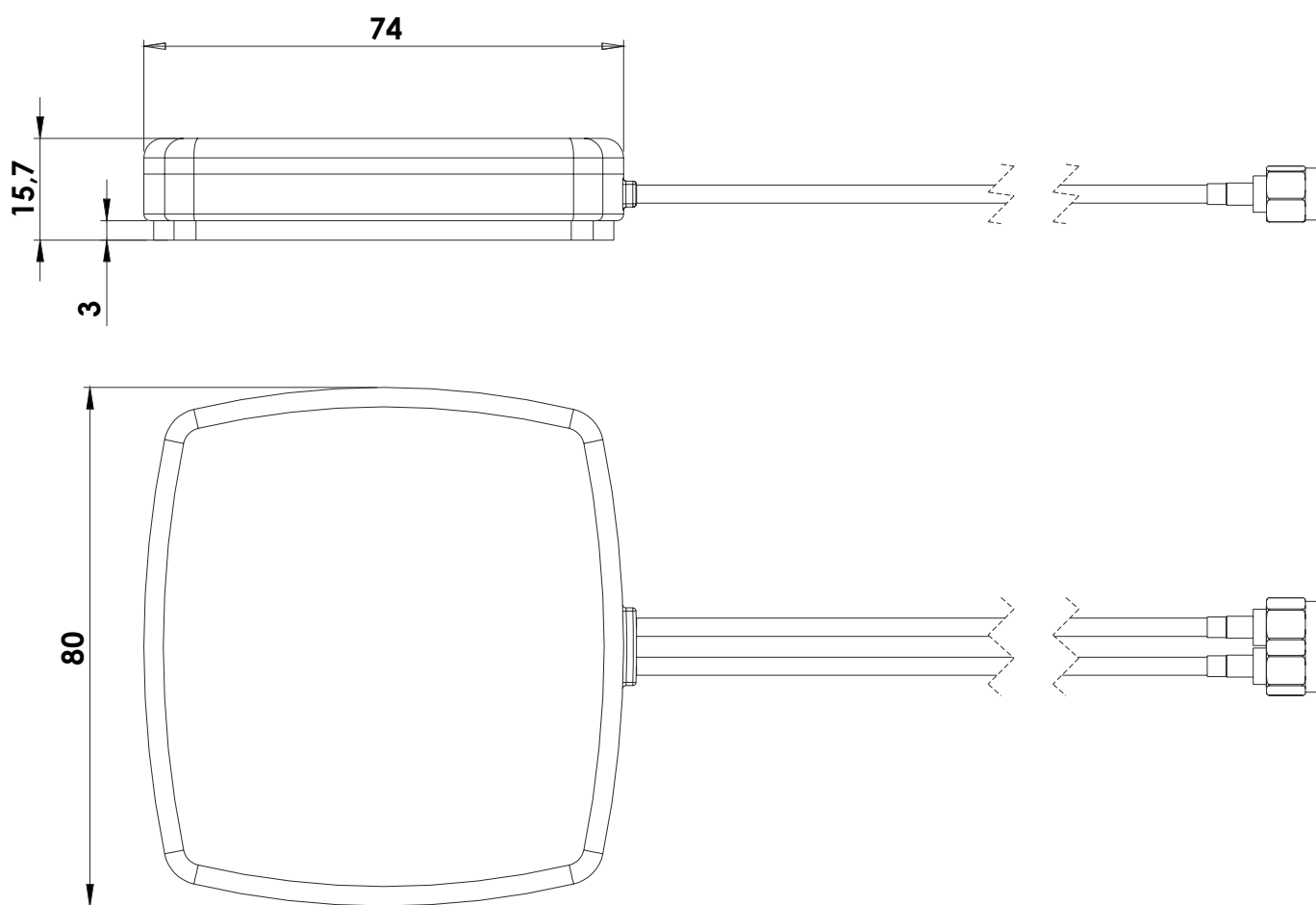

5. Antenna Images

