

2J6047B

Cellular/LTE and 2.4/5.0 GHZ ISM Screw Mount

Key Features

Cable 1: CELLULAR / LTE

- 698-960 MHz
- 1710-2170 MHz
- 2500-2700 MHz

Cable 2: 2.4/5.0 GHz ISM

- 2410-2490 MHz
- 4920-5925 MHz

Screw Mount

Ground Plane Independent

Customizable Cable and Connector

Dimensions 80 x 74 x 14.7 mm

Certificates: IP67



Note: 19mm Thread is Default Option. See Drawing for other Thread Options available.



1. Antenna and electrical specifications

Cable 1

Parameters	CELLULAR / LTE Antenna		
Standards	2G,3G and 4G		
Band (MHz)	700/850/900	1700/1800/1900/2100	2600
Frequency (MHz)	698-960	1710-2170	2500-2700
Return Loss (dB)	~-7.7	~-7.6	~-17.0
VSWR	~2.4:1	~2.4:1	~1.4:1
Efficiency (%)	~26.2	~37.1	~54.8
Peak Gain (dBi)	~-0.3	~4.6	~6.2
Average Gain (dB)	~-5.9	~-4.3	~-2.6
Impedance (Ohm)	50		
Polarisation	Linear		
Radiation Pattern	Omni-Directional		
Max. Input Power (W)	25		
Connector Type	SMA-Male Standard (Other Connectors Available)		
Cable Length	300 cm Standard (Any Cable Length Available)		
Cable Type	DACAR302 Standard (Other Cables Available)		

Cable 2

Parameters	2.4/5.0 GHz ISM Antenna	
Standards	WiFi, BT, ZigBee, ISM	
Band (MHz)	2.4 GHz	5.0 GHz
Frequency (MHz)	2410-2490	4920-5925
Return Loss (dB)	~-11.9	~-14.7
VSWR	~1.8:1	~1.5:1
Efficiency (%)	~43.4	~31.9
Peak Gain (dBi)	~-4.5	~-3.9
Average Gain (dB)	~-3.6	~-5.1
Impedance (Ohm)	50	
Polarisation	Linear	
Radiation Pattern	Omni-Directional	
Max. Input Power (W)	25	
Connector Type	RP-SMA-Male Standard (Other Connectors Available)	
Cable Length	300 cm Standard (Any Cable Length Available)	
Cable Type	LMR100 Standard (Other Cables Available)	

Antenna Measurement Conditions:

Mounted on 30 x 30 x 0.25 cm Metal Plate
 200 cm of Cable DACAR302 and LMR100
 Measured in Certified CTIA 3D Anechoic Chamber

2. Mechanical and environmental specifications

Specifications	2J6047B
Mounting Type	Screw Mount
Dimensions (mm)	80 x 74 x 14.7
Max. Tighten Torque (Nm)	5 Nm
Radome	ABS
Radome color	Black
Operating Temperature (C)	-40 to +85
Storage Temperature (C)	-40 to +85
Substance Compliance	RoHS
Certificates	IP67

3. Antenna parameters

Cable 1: CELLULAR/LTE

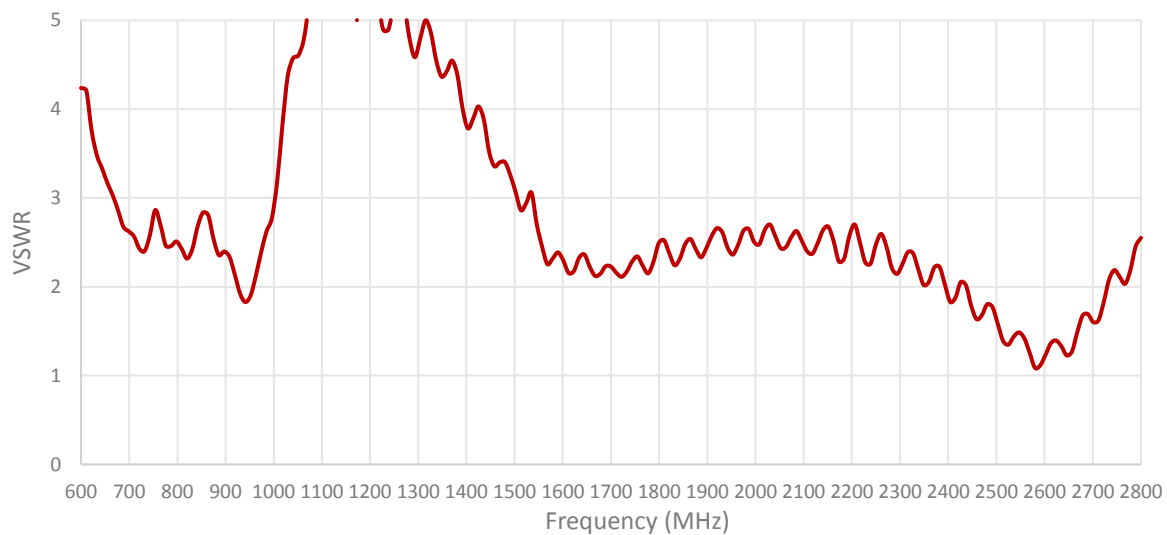
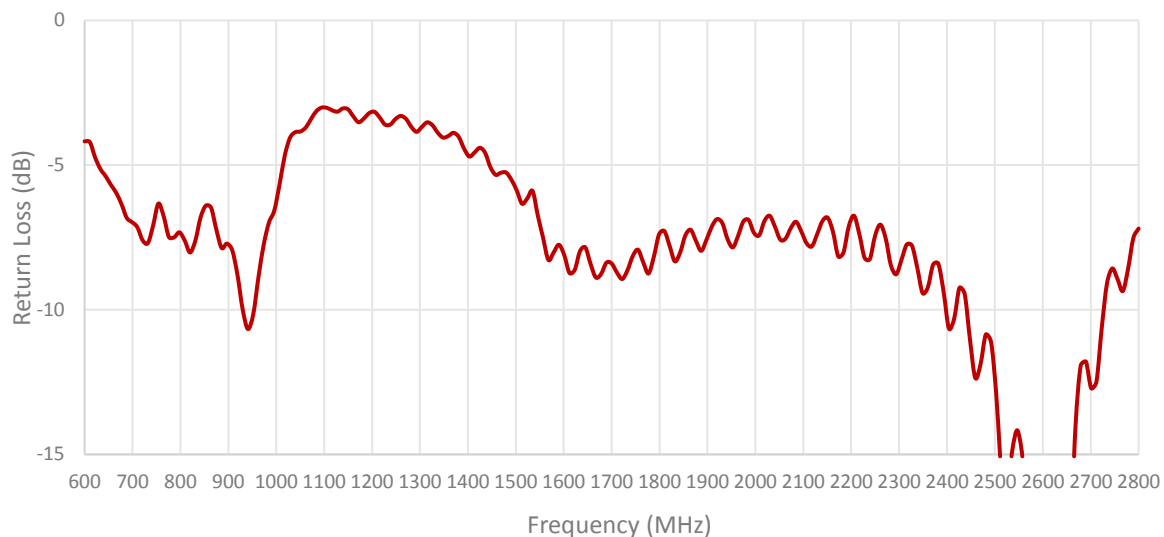

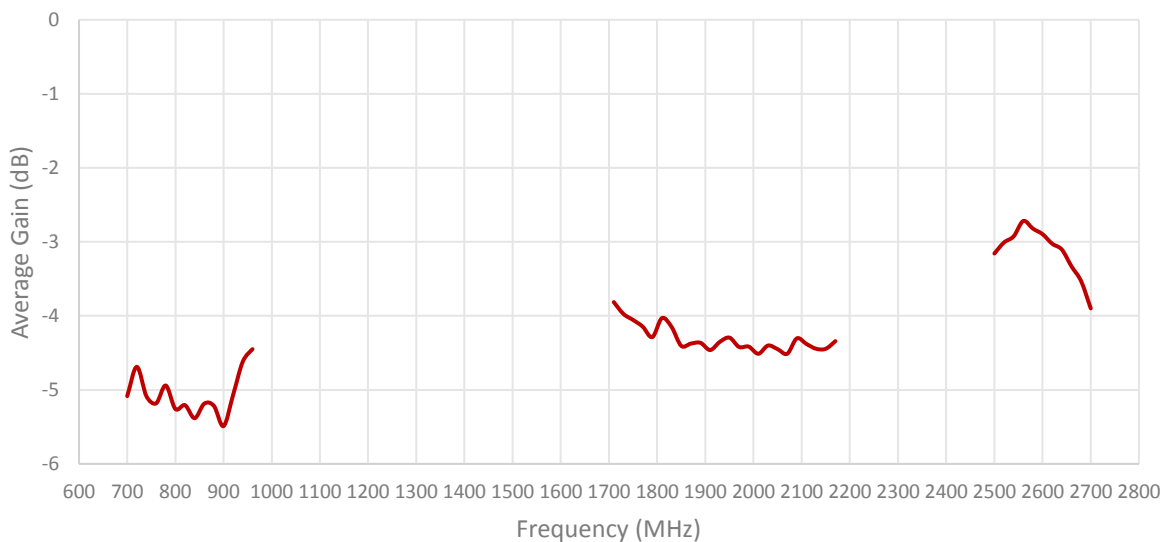
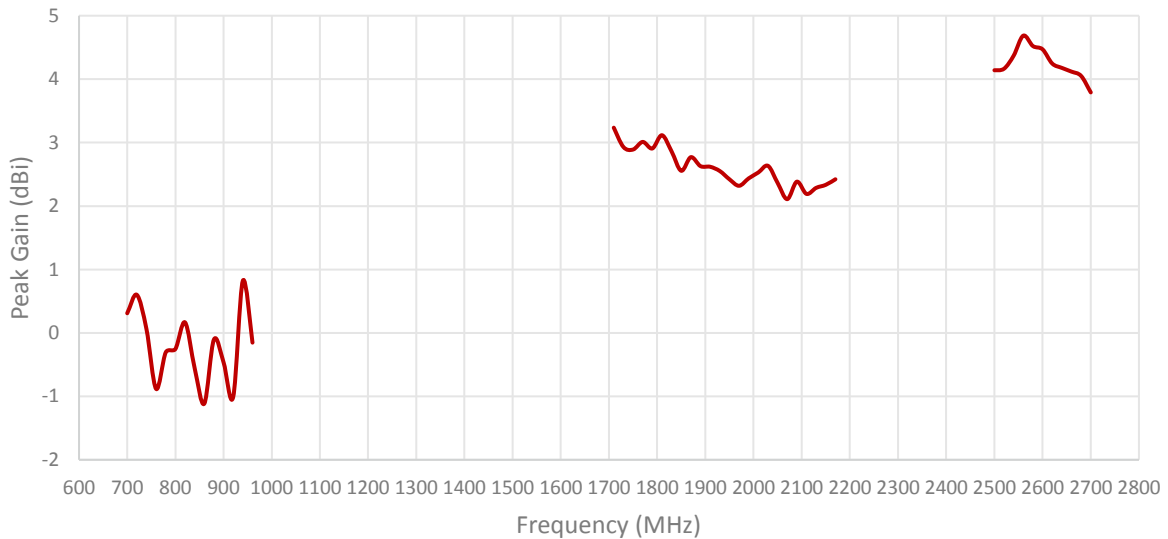
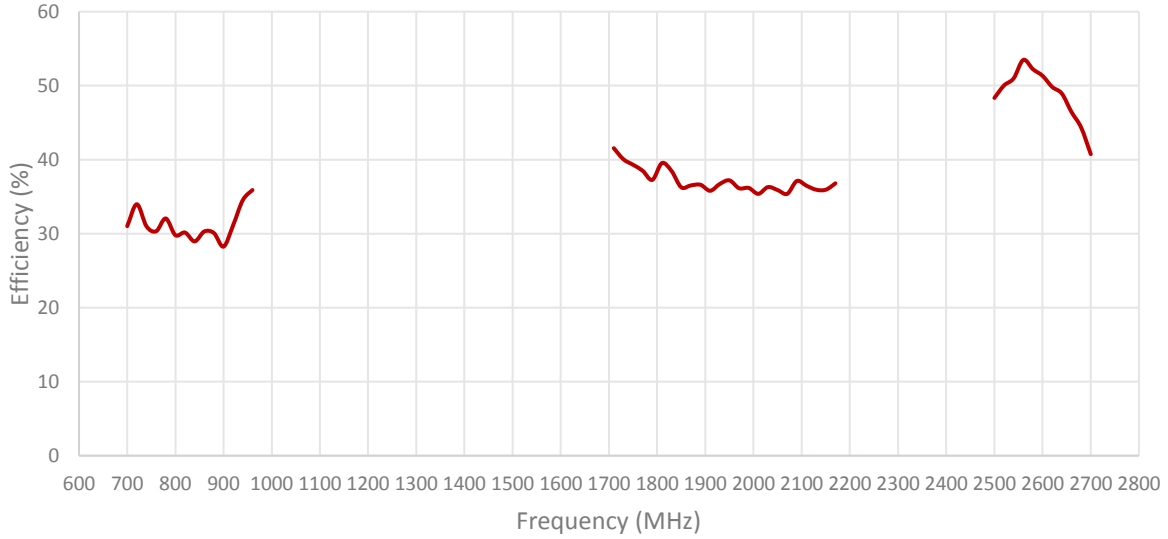

Cable 2: 2.4/5.0 GHz ISM

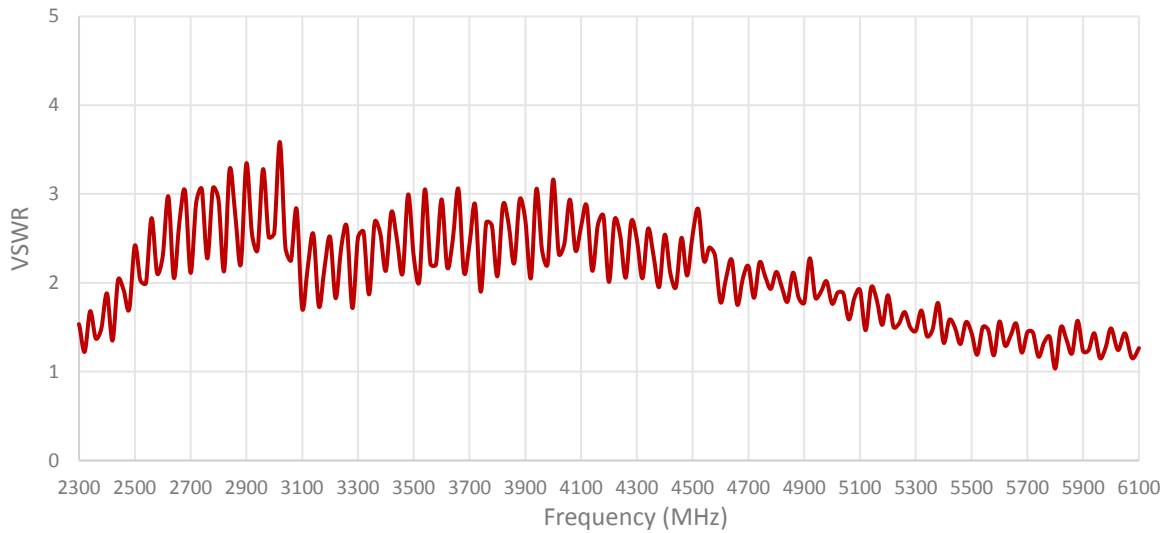
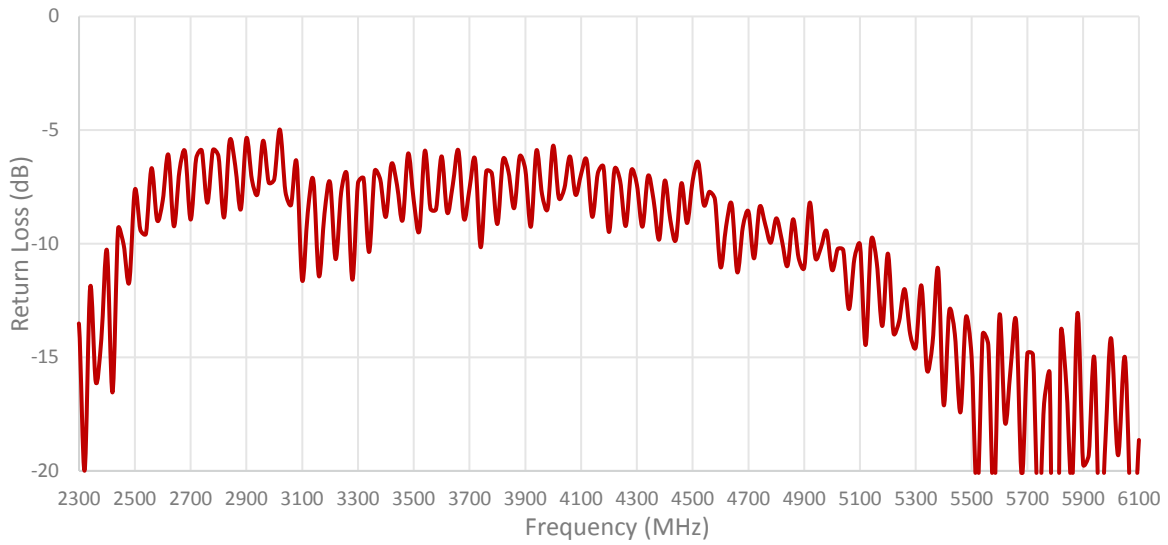

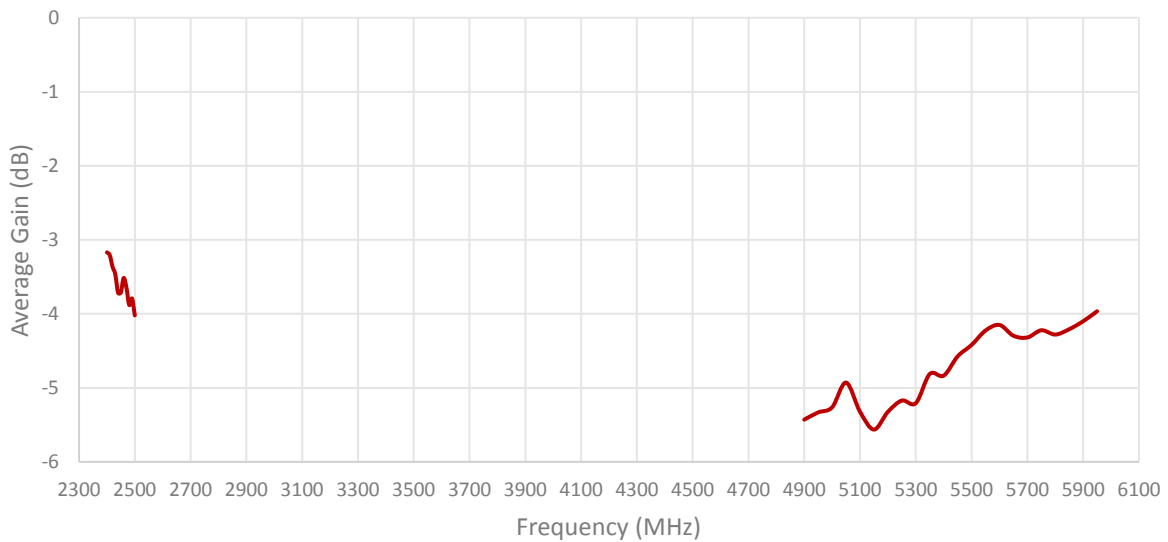
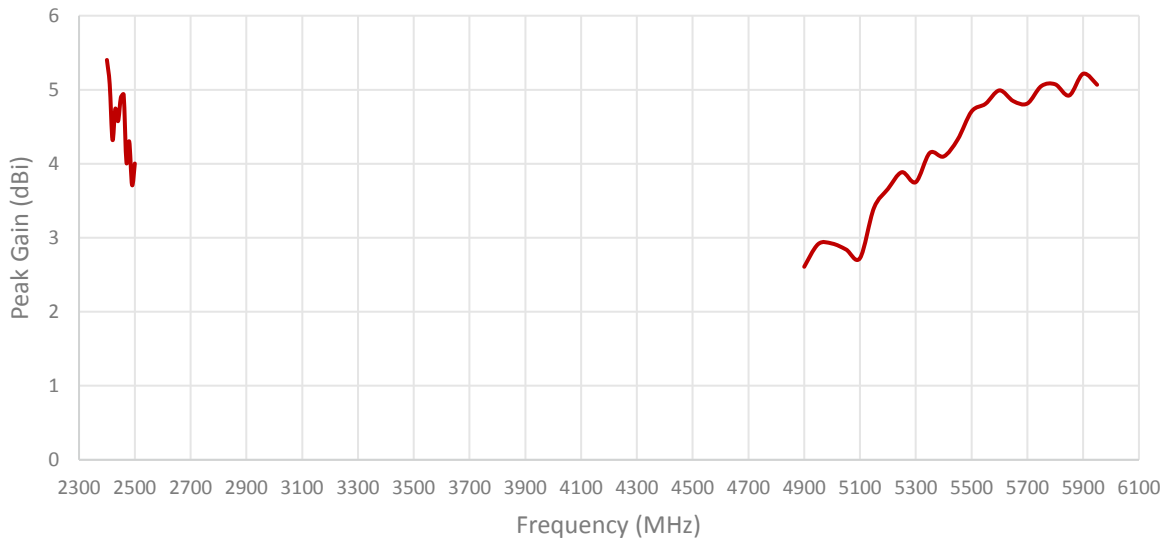
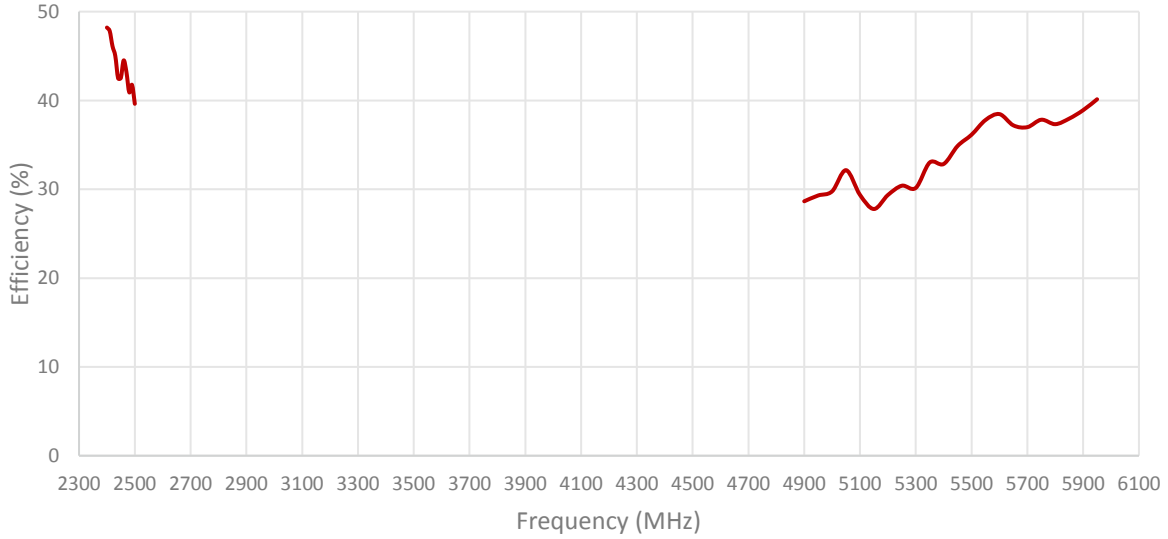

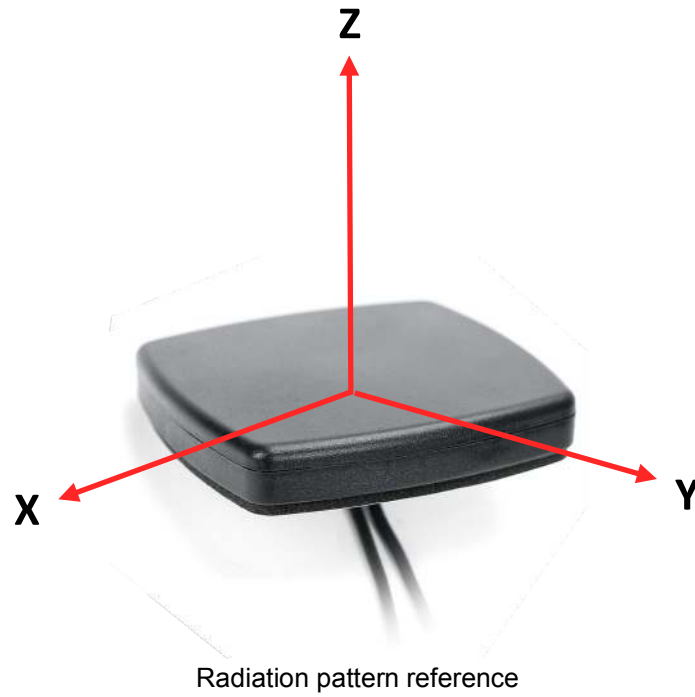

Cable 1: CELLULAR/LTE

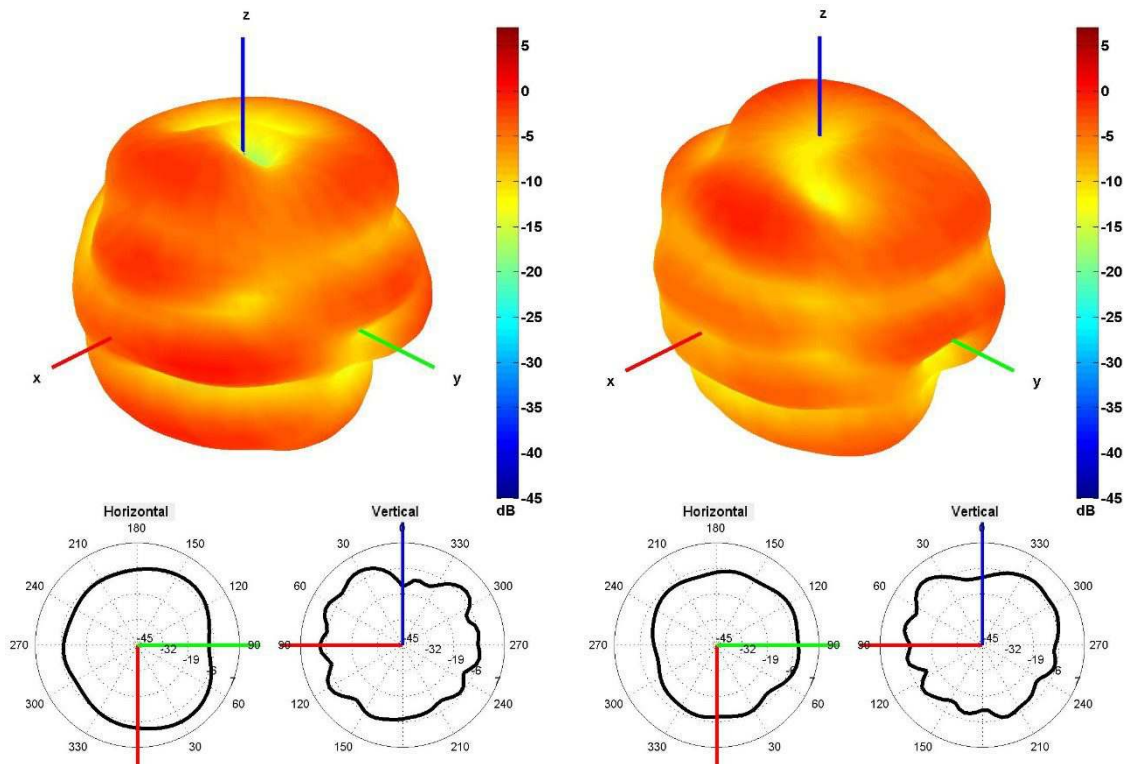

750 and 850 MHz Radiation pattern

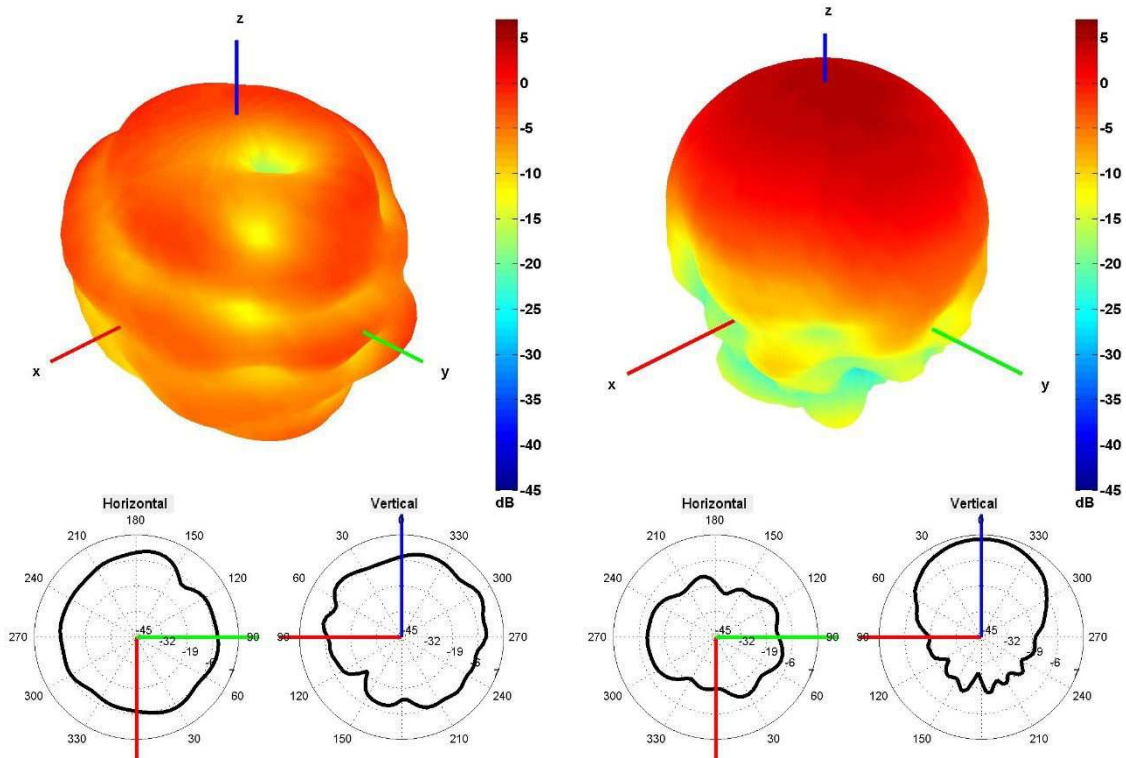

940 and 1750 MHz Radiation pattern

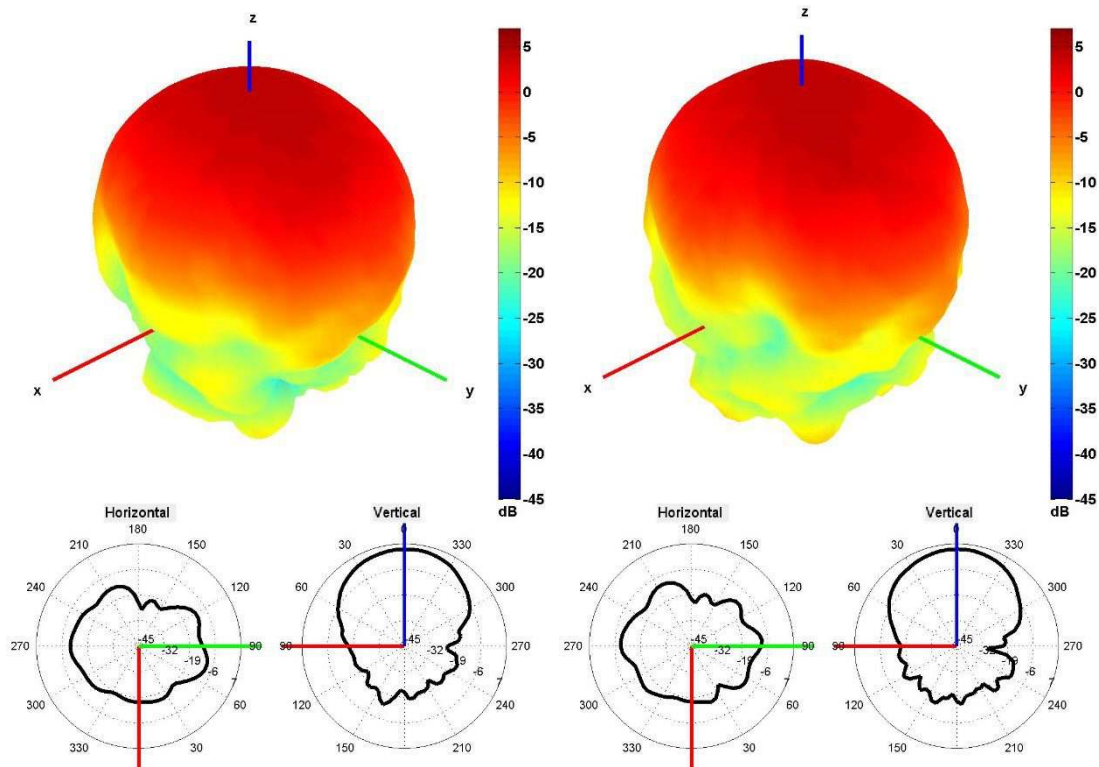

1850 and 1950 MHz Radiation pattern

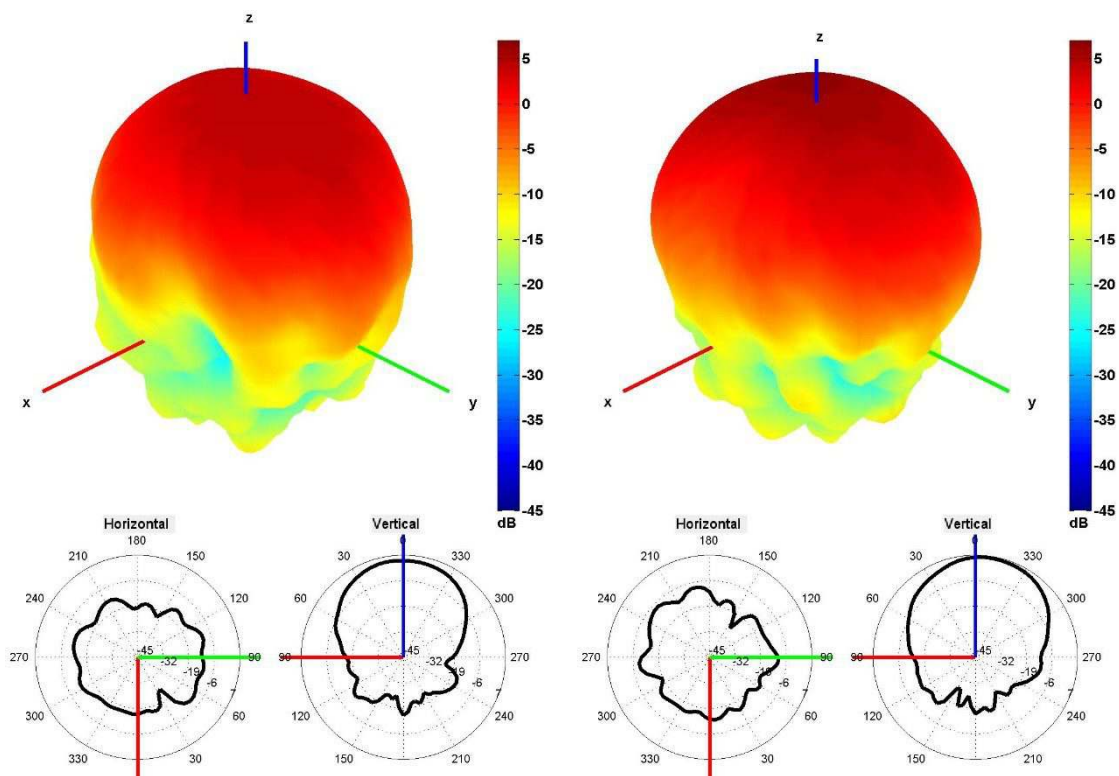

2100 and 2600 MHz Radiation pattern

Cable 2: 2.4/5.0 GHz ISM

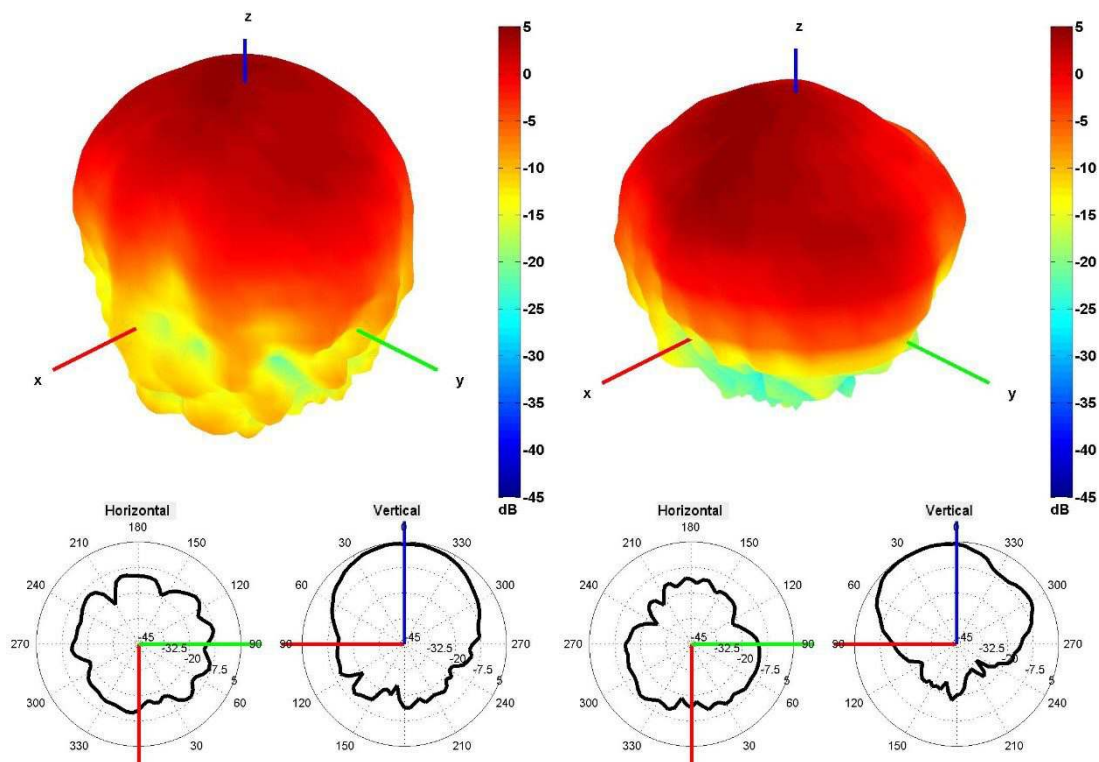

2450 and 5500 MHz Radiation pattern

4. Antenna drawings

Default Thread Option

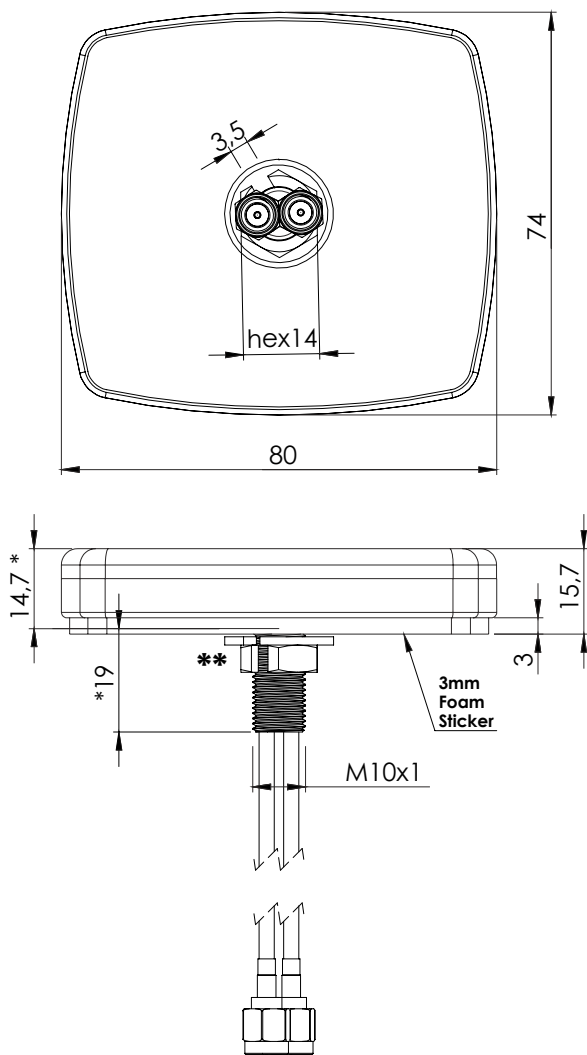

2J6047B-TH19
19 mm Thread
Default Option

Other Thread Options available

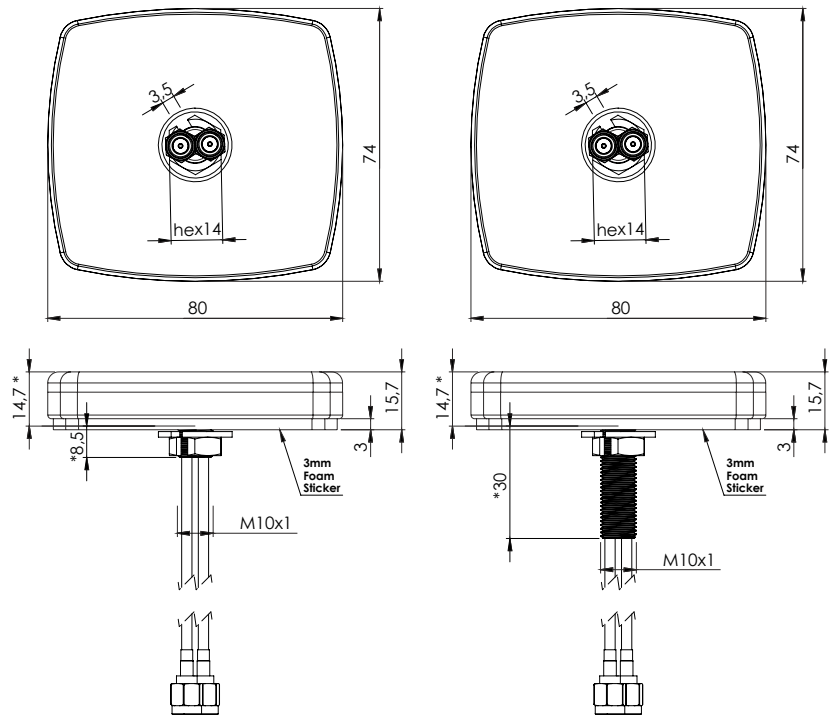

2J6047B-TH8,5
8,5 mm Thread

2J6047B-TH30
30 mm Thread

***Dimensions after mounting**
****Max. Torque= 5 Nm**

5. Antenna Images

