

2J7524M

CELLULAR / LTE Magnetic Mount

Key Features

CELLULAR / LTE

- 698-960 MHz
- 1710-2170 MHz
- 2500-2700 MHz

Magnetic Mount

High Performance

Ground Plane Dependent

Customizable Cable and Connector

Dimensions \varnothing 54 x 80 mm

Certificates IP67, IP69K



1. Antenna and electrical specifications

Parameters	CELLULAR / LTE Antenna		
Standards	2G,3G and 4G		
Band (MHz)	700/850/900	1700/1800/1900/2100	2600
Frequency (MHz)	698-960	1710-2170	2500-2700
Return Loss (dB)	~-11.2	~-12.8	~-14.3
VSWR	~2.1:1	~1.6:1	~1.5:1
Efficiency (%)	~56	~51	~43
Peak Gain (dBi)	~2.0	~3.9	~3.5
Average Gain (dB)	~-2.6	~-2.9	~-3.6
Impedance (Ohm)	50		
Polarisation	Linear		
Radiation Pattern	Omni-Directional		
Max. Input Power (W)	25		
Connector Type	SMA-Male Standard (Other Connectors Available)		
Cable Length	300 cm Standard (Any Cable Length Available)		
Cable Type	LMR100 Standard (Other Cables Available)		

Antenna Measurement Conditions:

Mounted on 30 x 30 cm Metal Plate

200 cm of LMR100

Measured in Certified CTIA 3D Anechoic Chamber

2. Mechanical and environmental specifications

Specifications	2J7524M
Mounting Type	Magnetic Mount
Dimensions (mm)	Ø 54 × 80
Radome	ASA
Radome color	Black
Antenna Base	Zamak
Gasket	TPE
Operating Temperature (C)	-40 to +85
Storage Temperature (C)	-40 to +85
Substance Compliance	RoHS
Certificates	IP67, IP69K

3. Antenna parameters

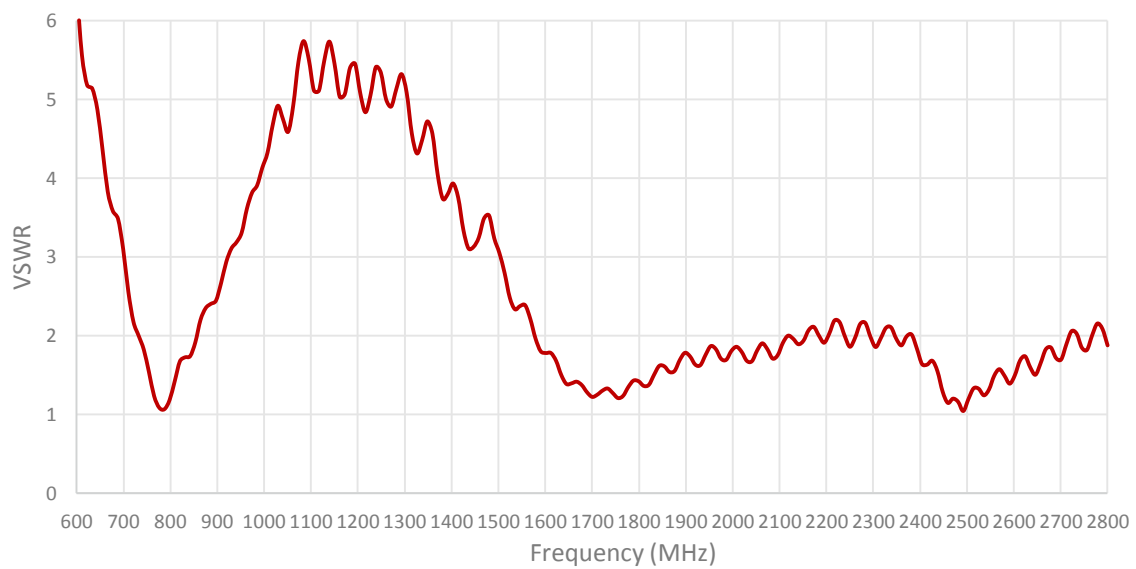
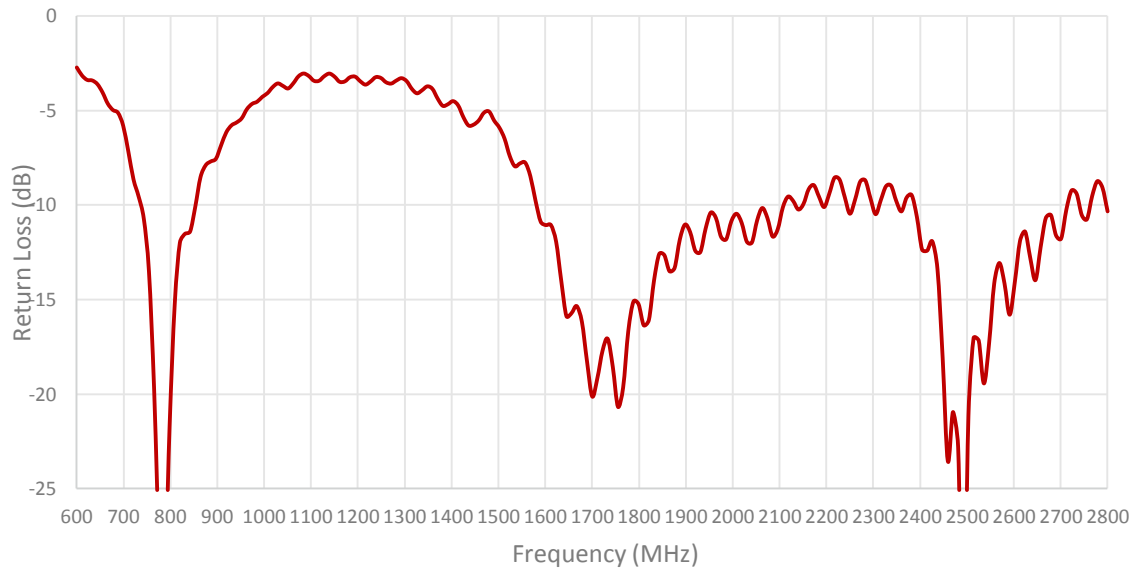

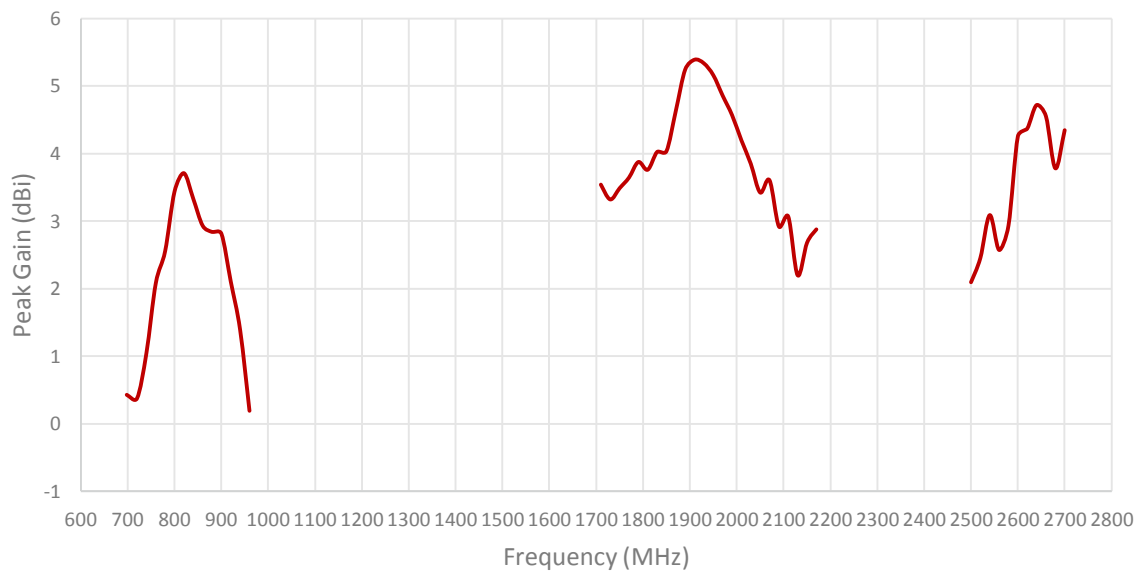
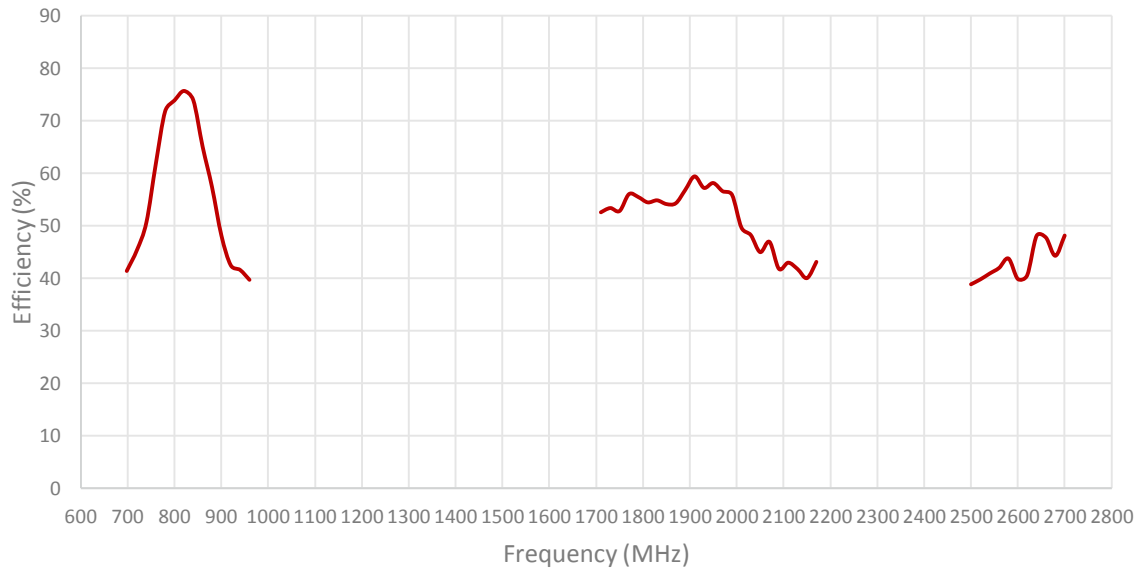

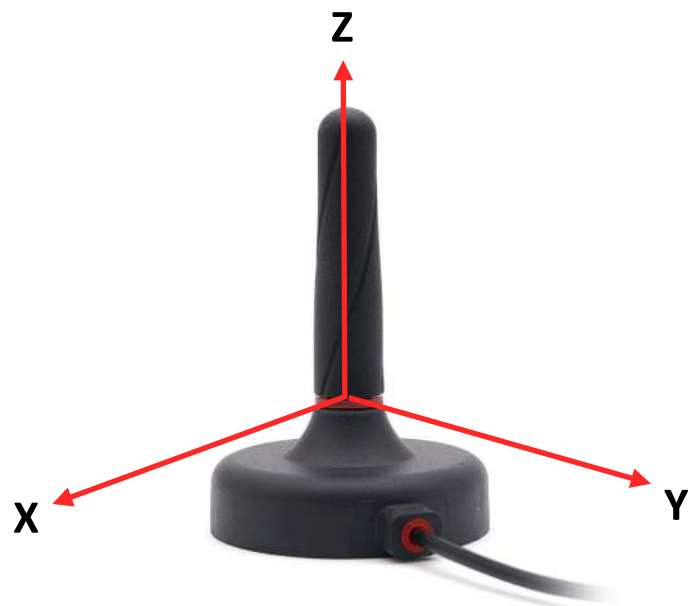
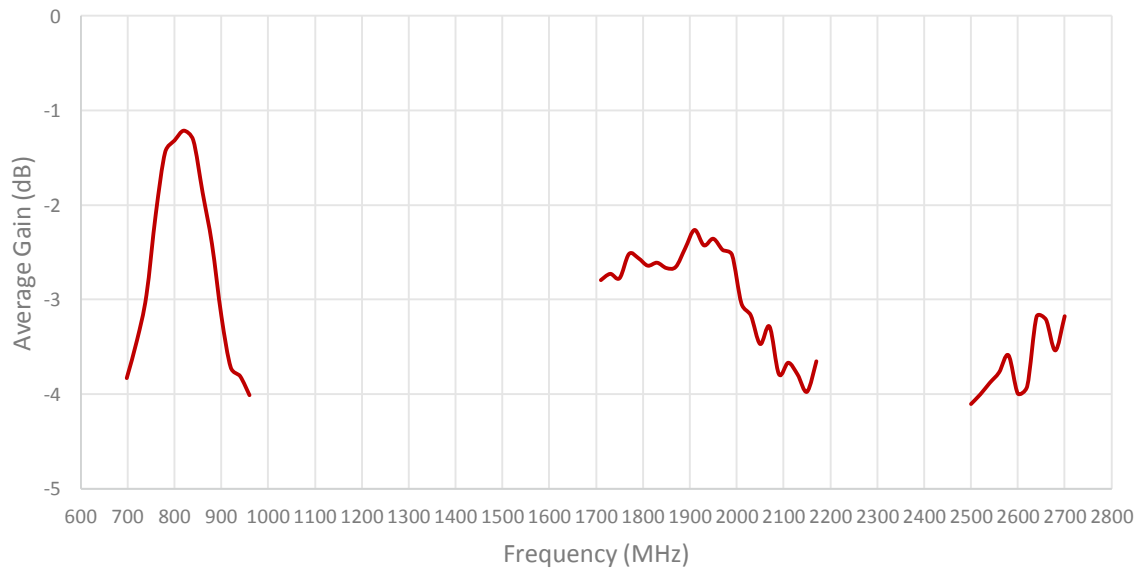

Radiation pattern reference

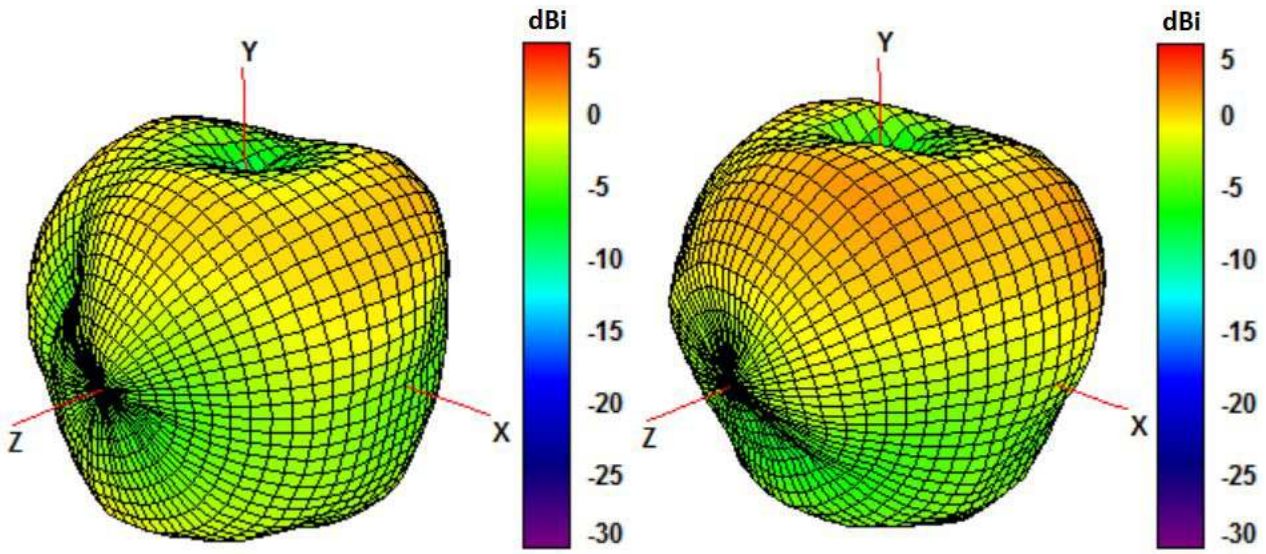

750 and 850 MHz Radiation pattern

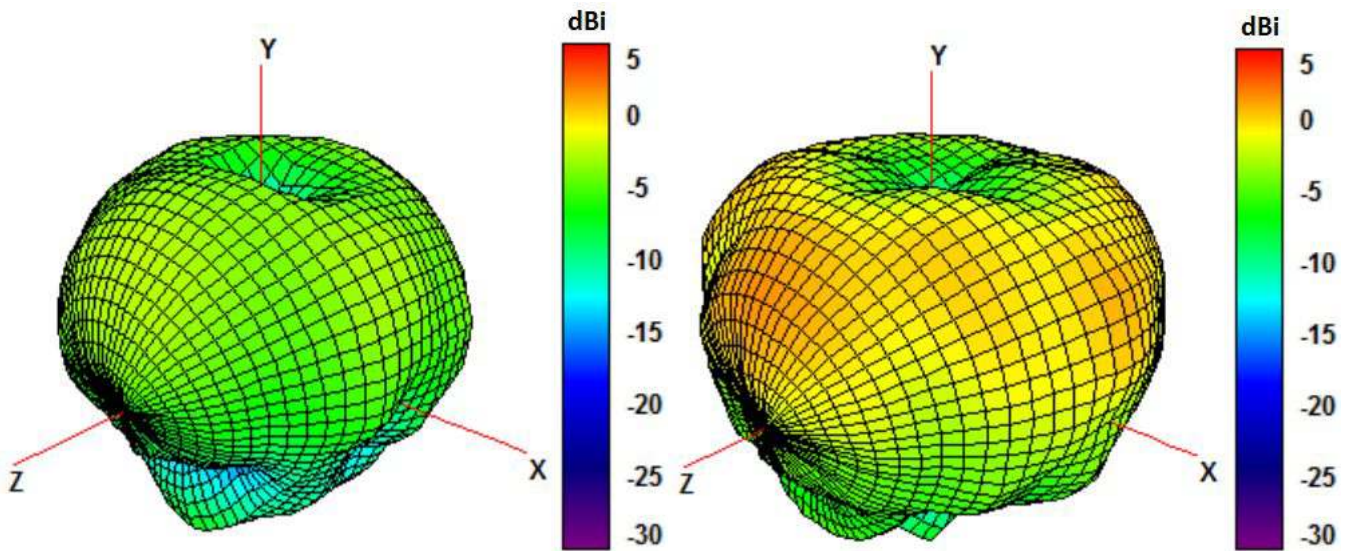

940 and 1750 MHz Radiation pattern

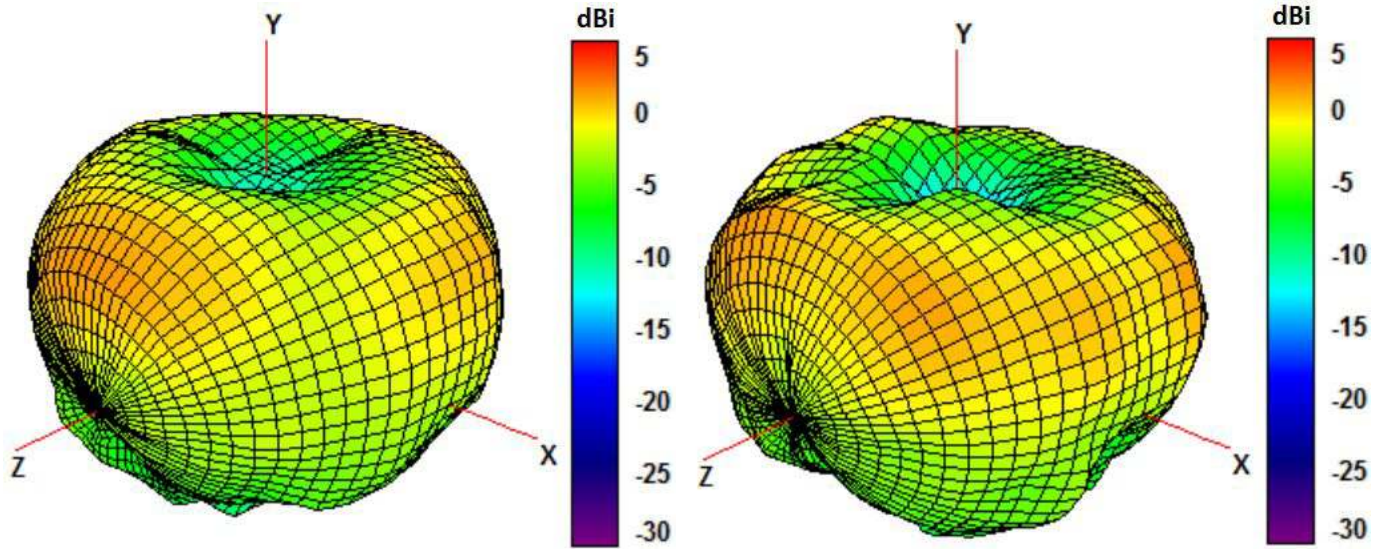

1850 and 1950 MHz Radiation pattern

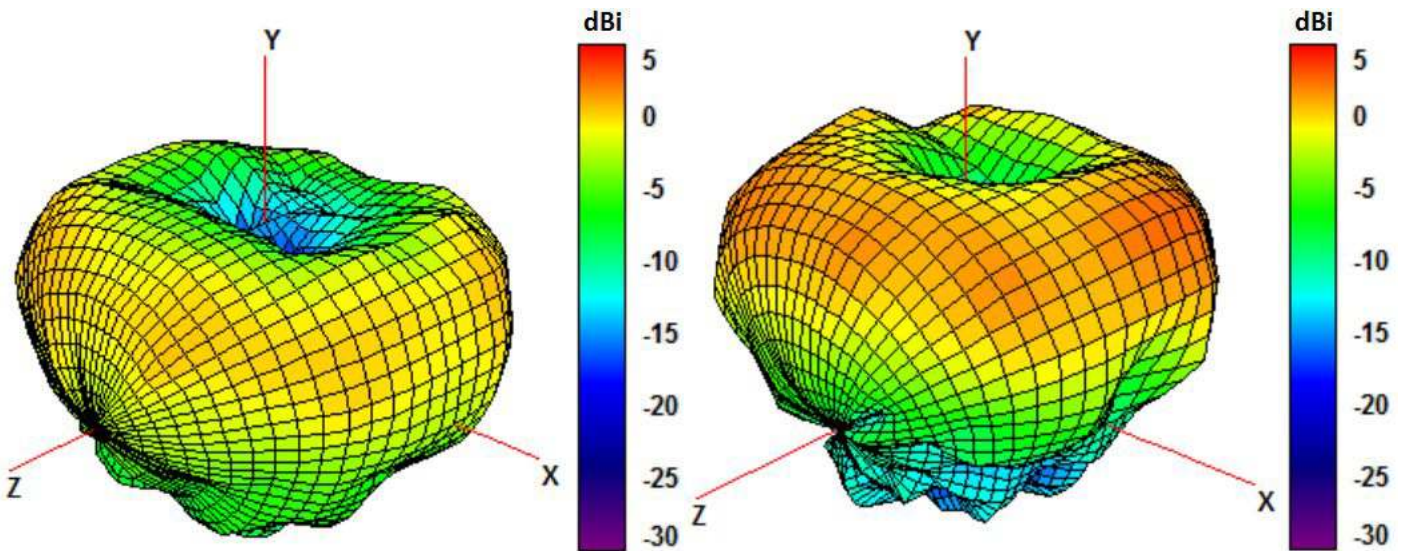

2100 and 2600 MHz Radiation pattern

4. Antenna drawings

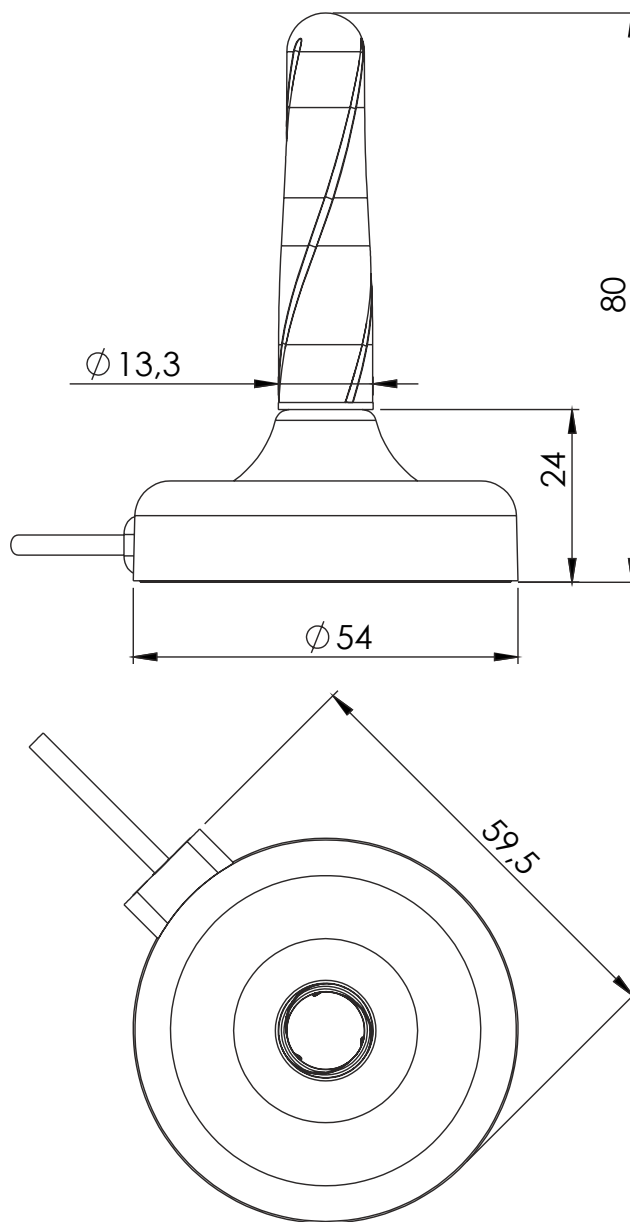

5. Antenna Images

