

2JL40

2.4/5.0 GHz ISM Surface Mount

Key Features

2.4/5.0 GHz ISM

- 2410-2490 MHz
- 4920-5925 MHz

Surface Mount

Easy to Integrate

Compact Size

Ceramic Material

Ground Plane Dependent

Dimensions 3.2 x 1.6 x 0.5 mm



1. Antenna and electrical specifications

Parameters	2.4 / 5.0 GHz ISM Antenna	
	WiFi, BT, ZigBee, ISM, SigFox, LoRa	
Standards	WiFi, BT, ZigBee, ISM, SigFox, LoRa	
Band (MHz)	2.4 GHz	5.0 GHz
Frequency (MHz)	2410-2490	4920-5925
Return Loss (dB)	~-12.6	~-11.7
VSWR	~1.6:1	~2.0:1
Efficiency (%)	~67.1	~56.2
Peak Gain (dBi)	~6.0	~1.1
Average Gain (dB)	~-1.7	~-2.5
Impedance (Ohm)	50	
Polarisation	Linear	
Radiation Pattern	Omni-Directional	
Max. Input Power (W)	10	

Antenna Measurement Conditions:

Mounted on ground plane of 80 x 40 mm

Measured in Certified CTIA 3D Anechoic Chamber

2. Mechanical and environmental specifications

Specifications	2JL40
Mounting Type	Surface Mount
Dimensions (mm)	3.2x 1.6 x 0.5
Material	Ceramic
Operating Temperature (C)	-40 to +85
Storage Temperature (C)	-40 to +85
Substance Compliance	RoHS

3. Antenna parameters

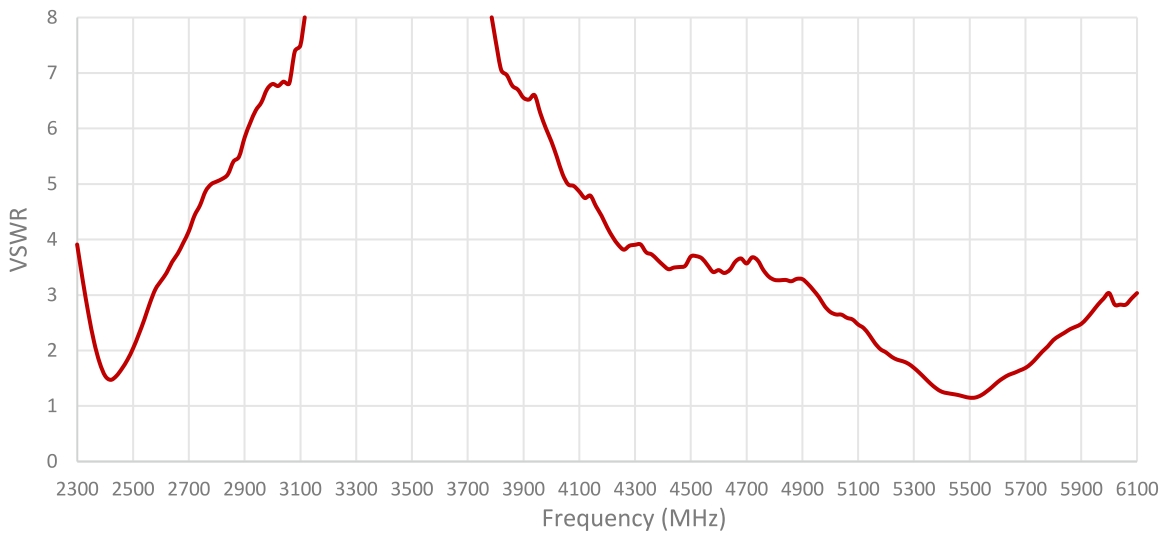
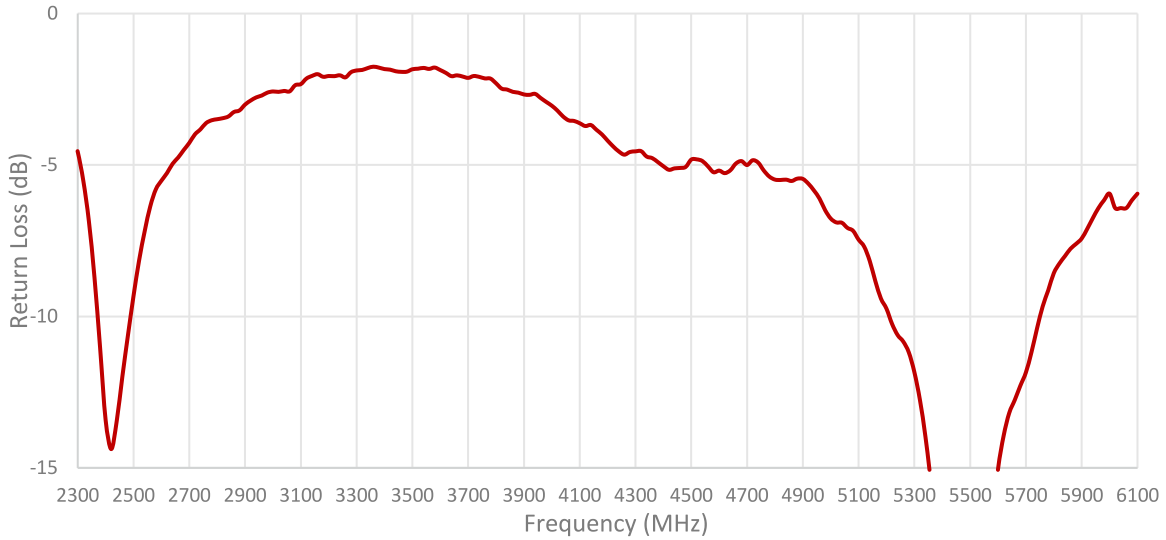

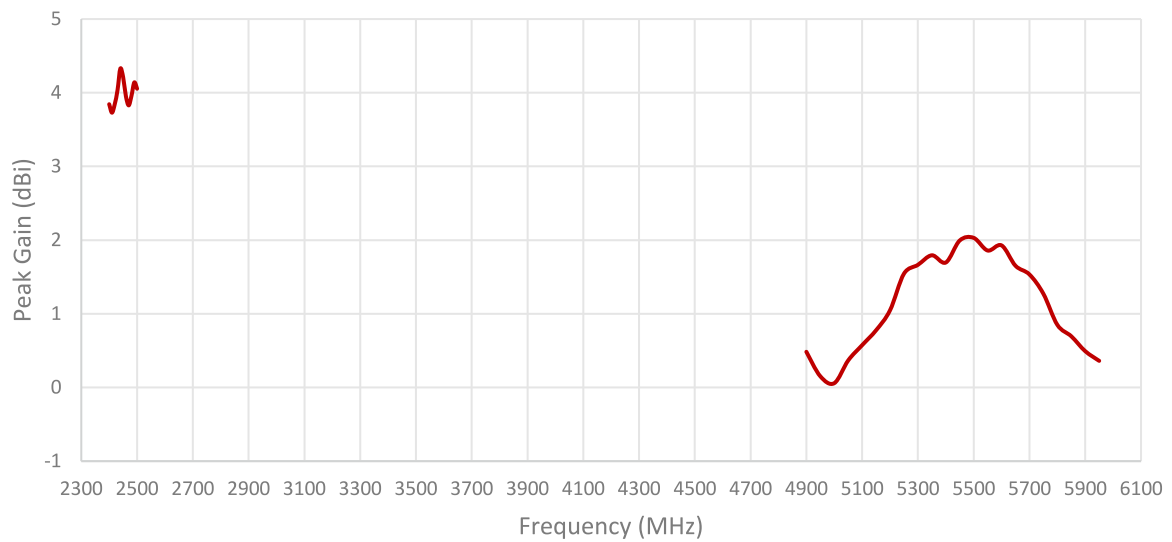
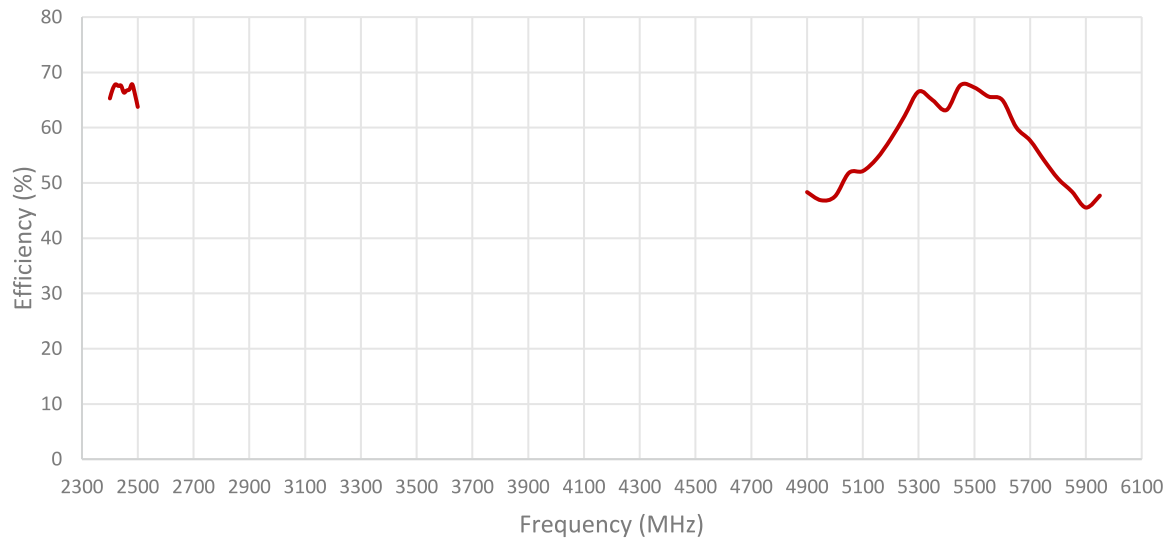

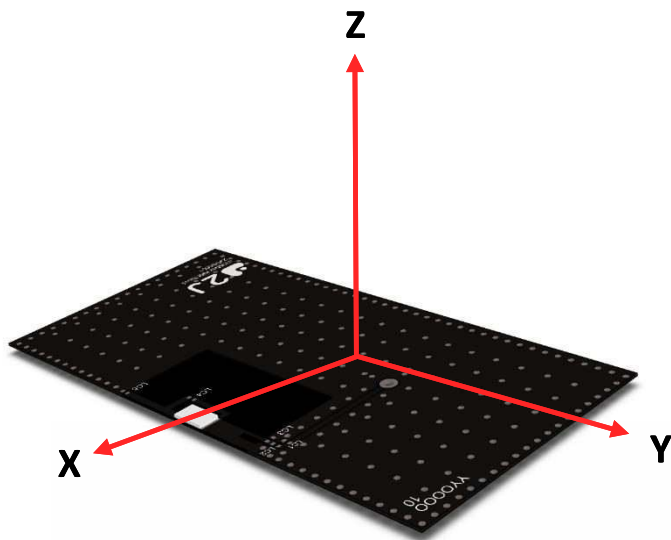
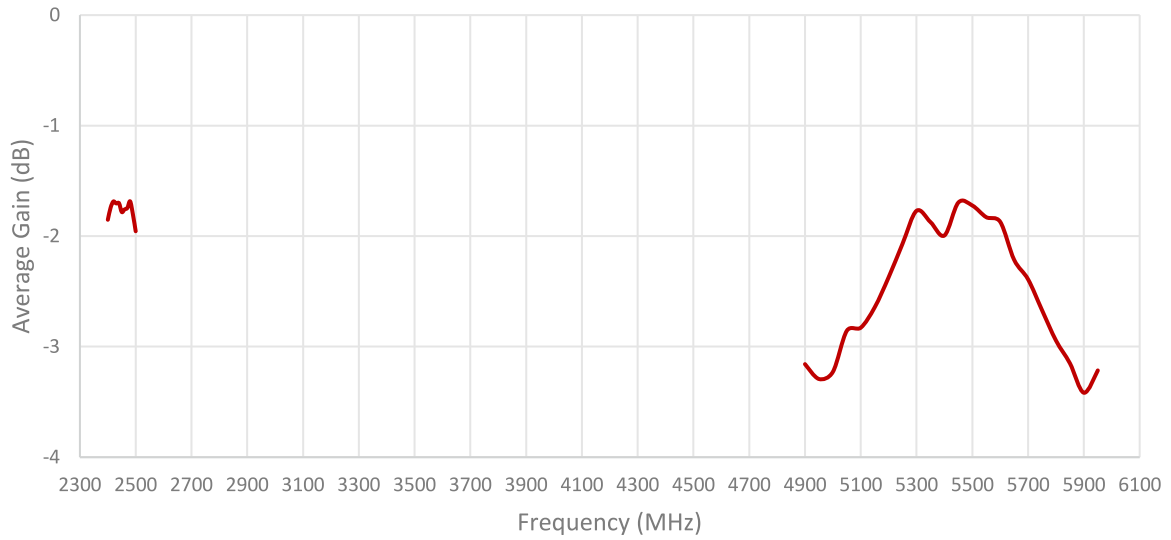

Radiation pattern reference

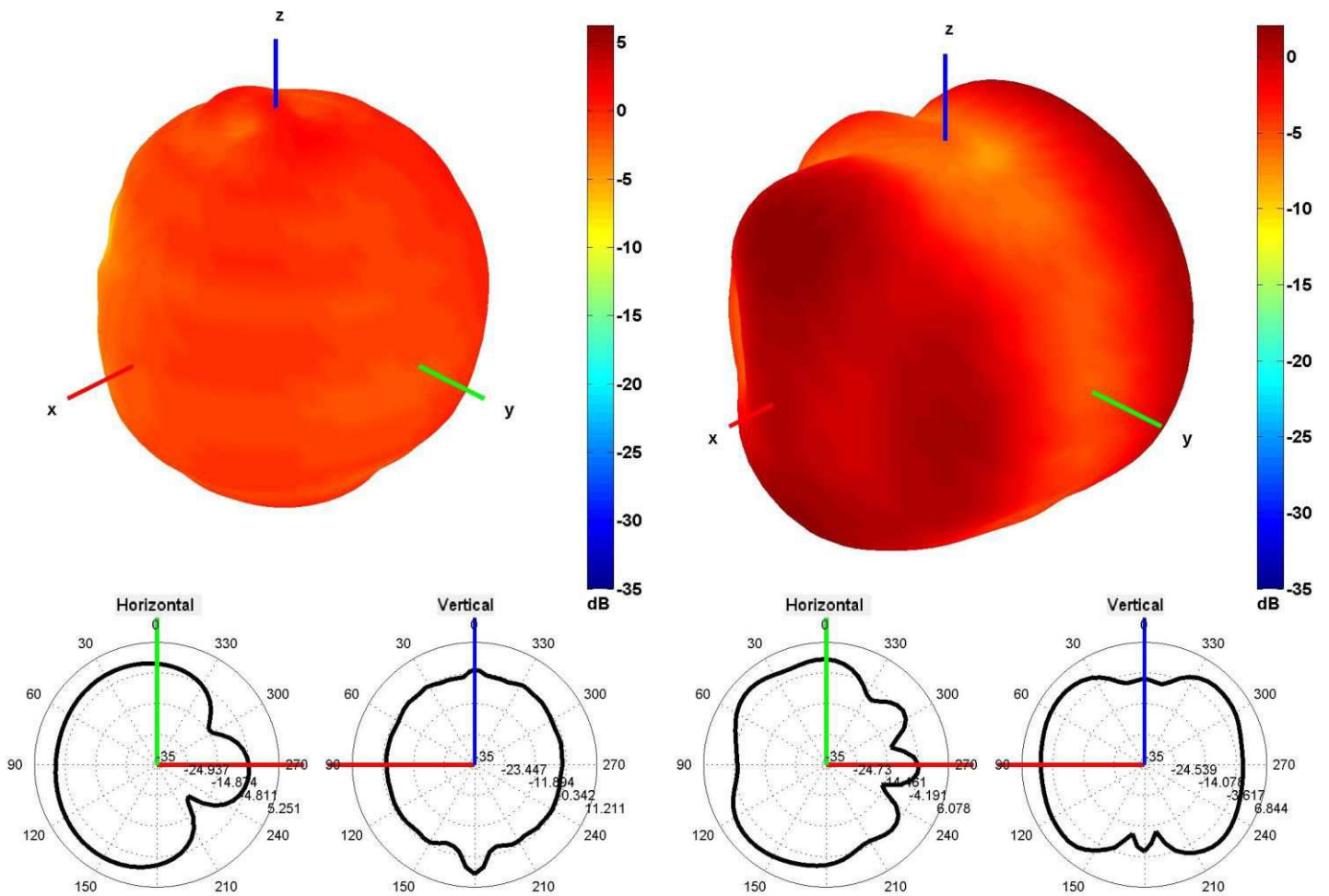

2450 and 5500 MHz Radiation pattern

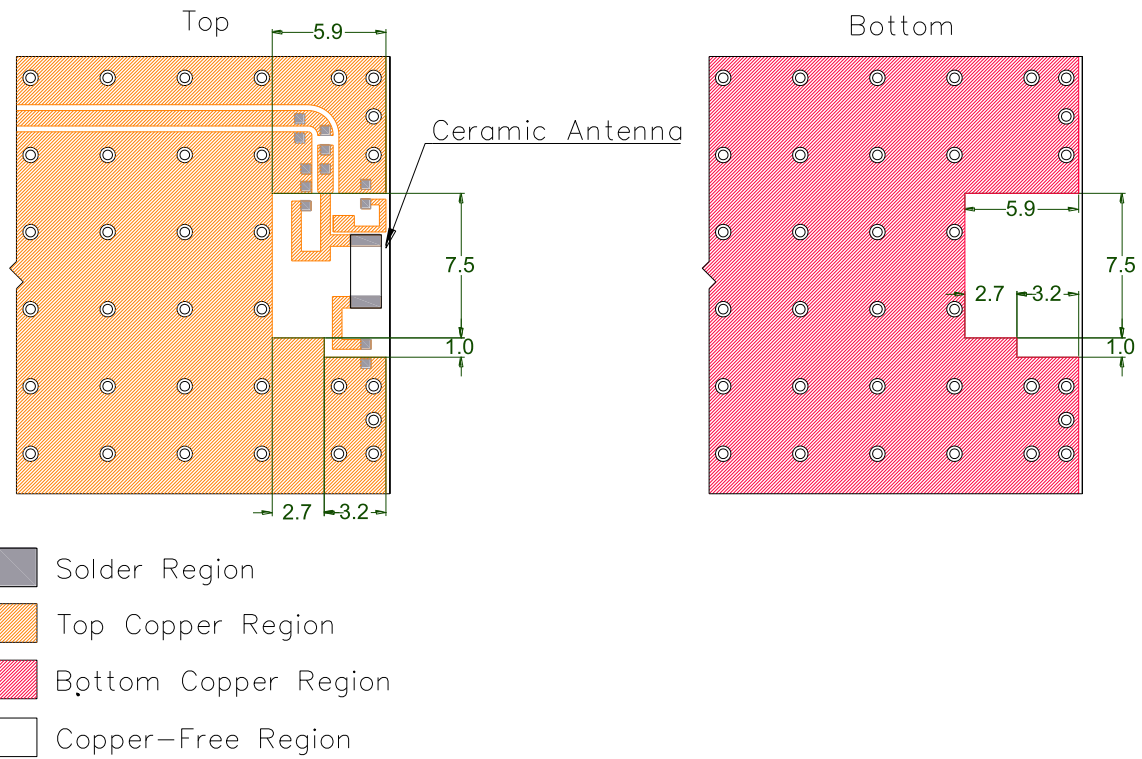

4. PCB Layout

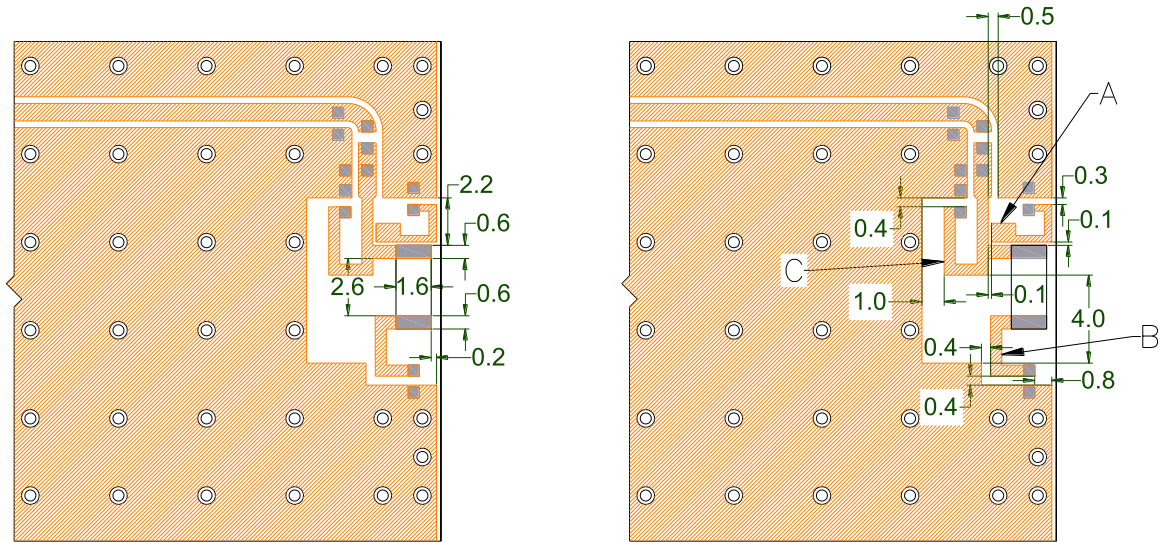

Minimum area required for antenna integration (15.6mm × 14.5mm)

4. PCB Layout



-  Solder Region
-  Top Copper Region
-  Copper-Free Region

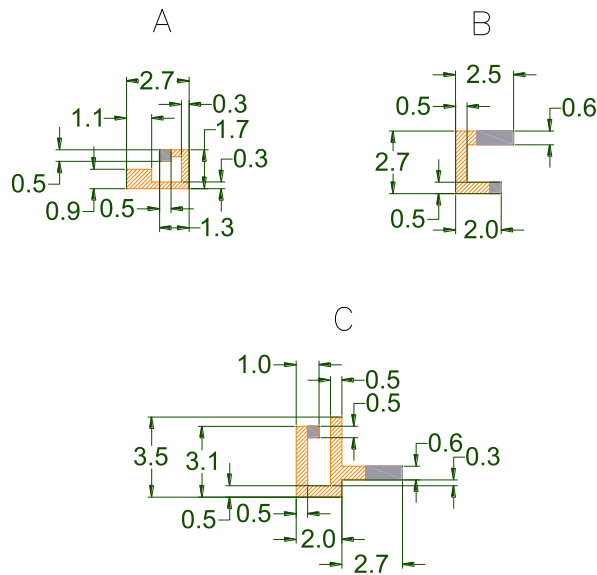

Layout dimensions for antenna integration (mm)

5. Matching Components

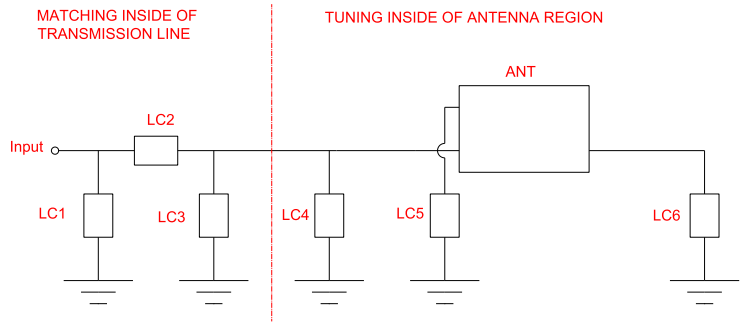

Matching Network Schematic

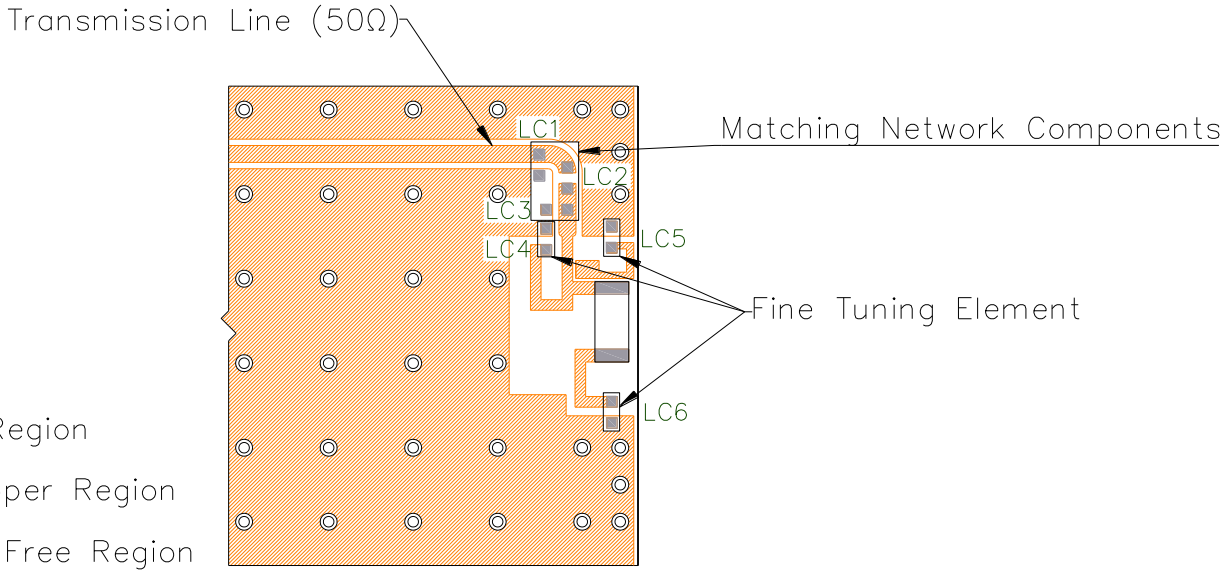

Matching network drawing (LC1=OPEN, LC2=1nH±0.03nH, LC3=OPEN, LC4=9pF±0.05pF, LC5=0.2pF±0.05pF, LC6=1.0pF±0.05pF)

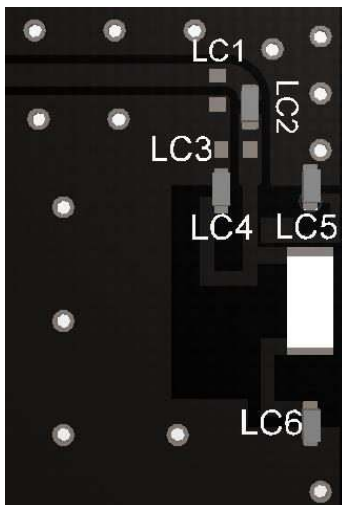

3D View of matching components and recommended values

REFLOW TEMPERATURE PROFILE

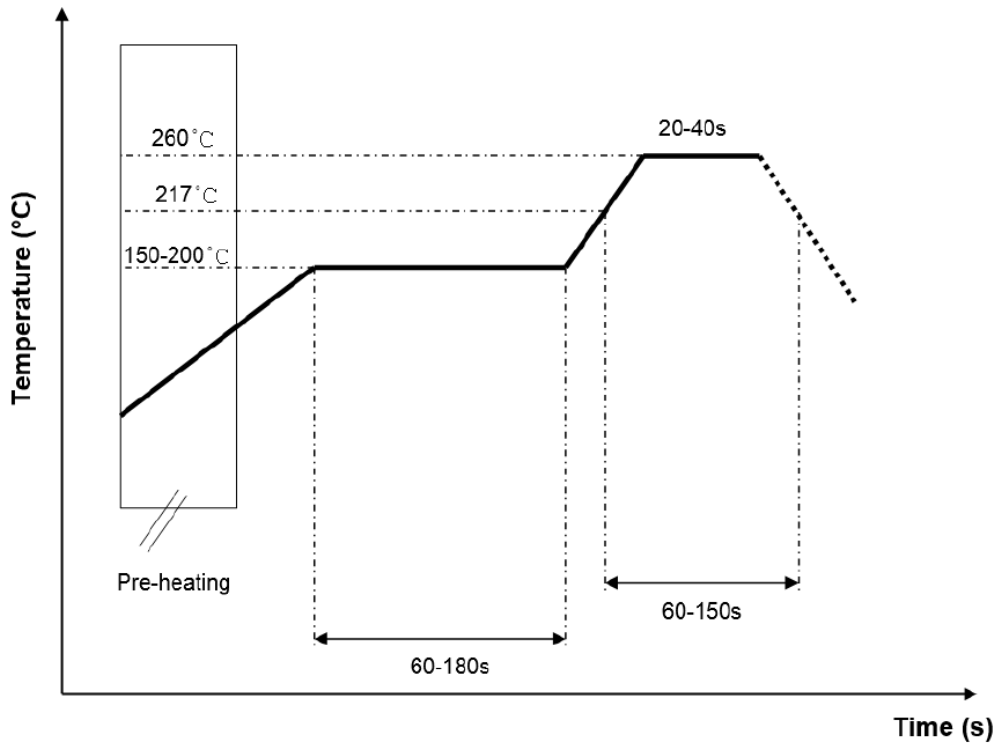

6. Evaluation Board

80mm x 40mm

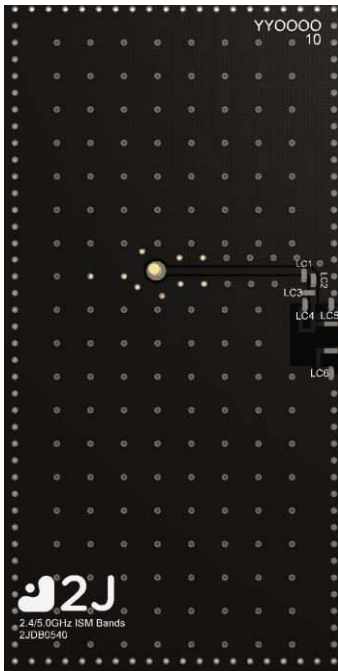

Front View without Antenna

80mm x 40mm

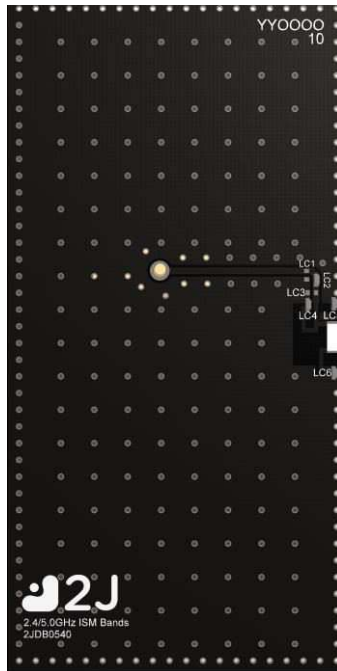

Front View with Antenna

80mm x 40mm

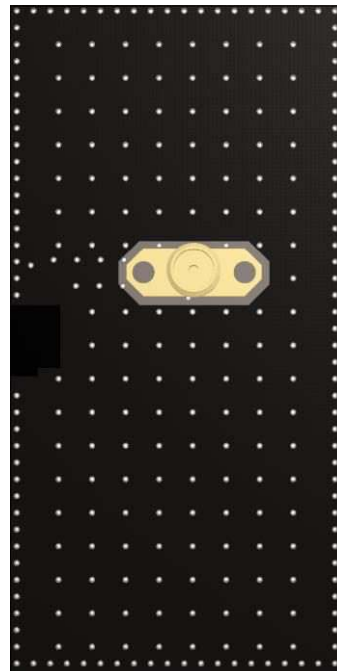

Back View

80mm x 10.8mm
(PCB: 0.8mm, Antenna: 0.5mm,
Connector: 9.5mm)



Side View

7. Antenna drawings

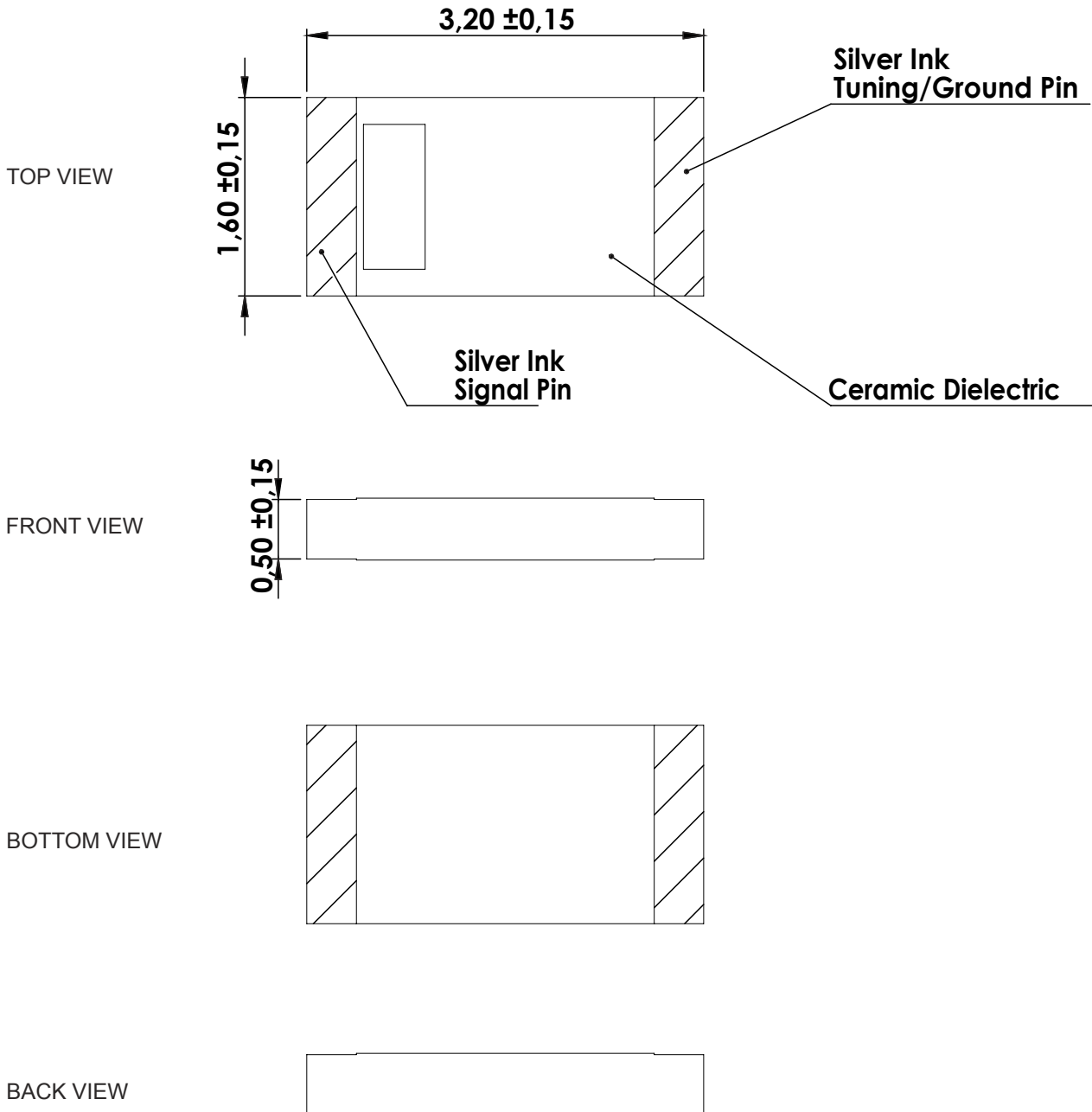

8. Tape and Reel Information

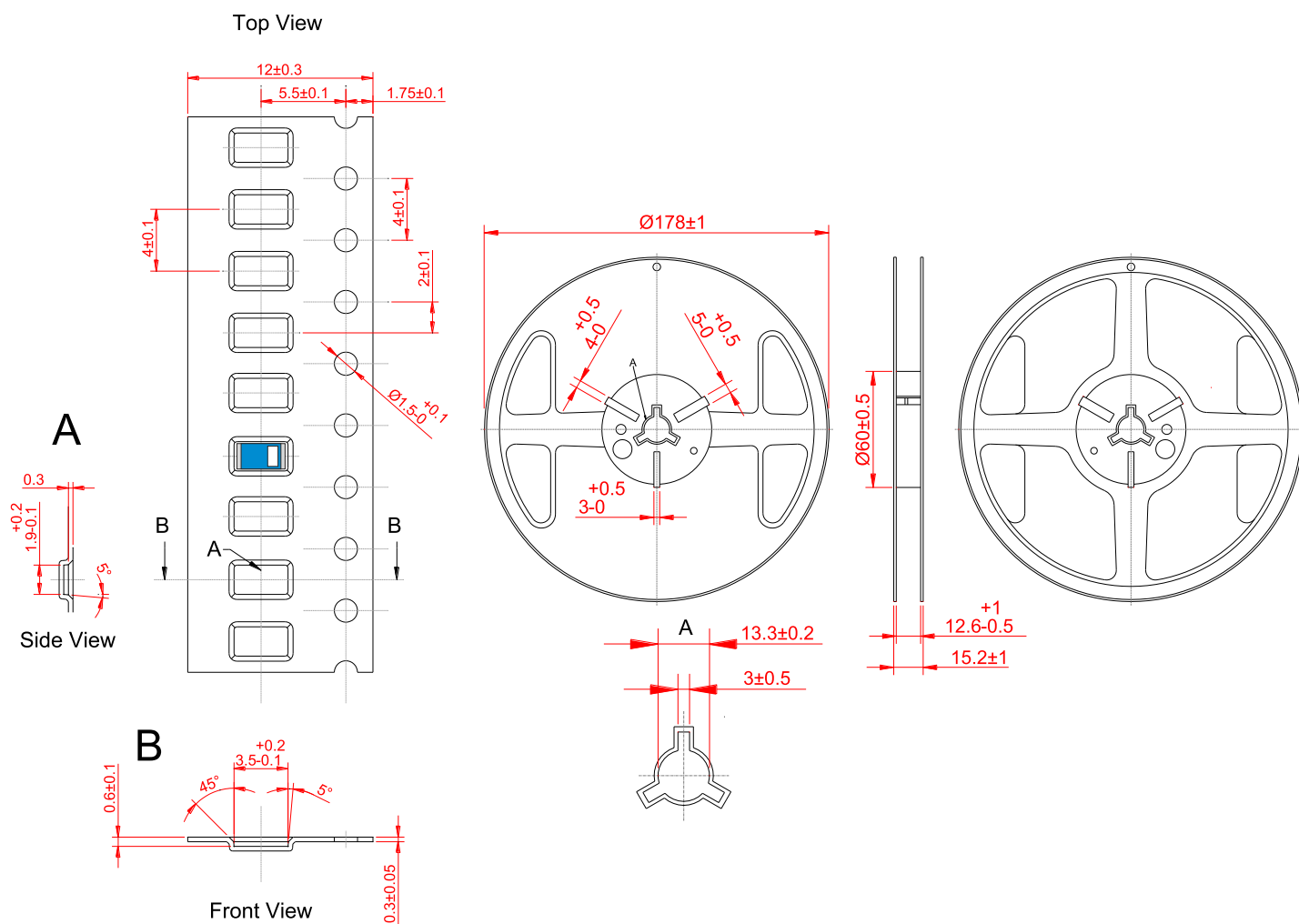

Tape and Reel Specifications

9. Packaging

PACKAGING SPECIFICATION

Antenna	2JL40
REEL	
Max Quantity per Reel	6000
REEL BOX	
Reels per Box	2
Max Quantity per Box	12000
Reel Box Dimensions (cm)	18 x 18 x 3.6
Reel Box Weight (Kg)	0.7
CARTON	
Reels per Carton	2
Max Quantity per Carton	120,000
Reel Carton Dimensions (cm)	40.5 x 24.7 x 22.5
Reel Carton Weight (Kg)	7

Storage Conditions:

- Storage Temperature Range: -40 °C to +85 °C
- Oxidizable material. Store for 12 months in vacuum sealed bag.
- Repack material after use by re-sealing package.

10. Antenna Images

