

2JW1483

5GNR Connector Mount

Key Features

5GNR

- 617-960 MHz
- 1525-2690 MHz
- 3300-3800 MHz

Connector Mount

Ultra Wide band Antenna

High Performance

Ground Plane Independent

Waterproof

Dimensions 192 × 20 × 18 mm

Certificates: IP67, IP69



1. Antenna and electrical specifications

Parameters	5GNR Antenna		
Technologies	5G, 4G, 3G and 2G		
Standards	5GNR/4GLTE/FirstNet/CBRS/LPWA/CAT-X/CAT-Mx/CAT-NBx/NB-IoT/3G/2G		
Frequency (MHz)	617-960	1427-2690	3300-3800
Band (MHz)	600, 700, 850, 900	1500, 1600, 1700, 1800, 1900, 2000, 2100, 2300, 2500, 2600	3300, 3500, 3600, 3700
5GNR Bands	n5, n8, 12, n20, n28, n71, n81, n82, n83,	n1, n2, n3, n7, n25, n34, n38, n39, n40, n41, n50, n51, n66, n70, n74, n75, n76, n80, n84, n86	n78
4GLTE Bands	B5, B6, B8, B12, B13, B14, B17, B18, B19, B20, B26, B27, B28, B29, B44, B67, B68, B71, B85	B1, B2, B3, B4, B7, B9, B10, B11, B21, B23, B24, B25, B30, B32, B33, B34, B35, B36, B37, B38, B39, B40, B41, B45, B50, B51, B65, B66, B69, B70	B22, B42, B43, B48, B49, B52
3GCELL Bands	B5, B6, B8, B12, B13, B14, B19, B20, B26	B1, B2, B3, B4, B7, B9, B10, B11, B21, B25, B32, B33, B34, B35, B36, B37, B38, B39, B40	B22
2GCELL Bands	710, 750, 810T, 850, 900P, 900E, 900R	1800DCS, 1900PCS	
CDMACELL Bands	BC0, BC2, BC3, BC7, BC9, BC10, BC12, BC18, BC19	BC1, BC4, BC6, BC8, BC13, BC14, BC15, BC16, BC20, BC21	
Return Loss (dB)	~-13.7	~-14.3	~-4.4
VSWR	~1.6:1	~1.7:1	~6.3:1
Efficiency (%)	~50.0	~55.2	~28.1
Peak Gain (dBi)	~-0.4	~-0.6	~-1.6
Average Gain (dB)	~-4.1	~-3.0	~-5.9
Impedance (Ohm)	50		
Polarisation	Linear		
Radiation Pattern	Omni-Directional		
Max. Input Power (W)	25		
Connector Type	SMA-Male		

Antenna Measurement Conditions:

Free Space

Measured in Certified CTIA 3D Anechoic Chamber

2. Mechanical and environmental specifications

Specifications	2JW1483
Mounting Type	Connector Mount
Dimensions (mm)	192 × 20 × 18
Radome	PC/ABS UV Stable
Radome color	Black or White
Connector Feature	Waterproof
Operating Temperature (C)	-40 to +85
Storage Temperature (C)	-40 to +85
Substance Compliance	RoHS, REACH
Certificates	IP67, IP69

3. Antenna parameters

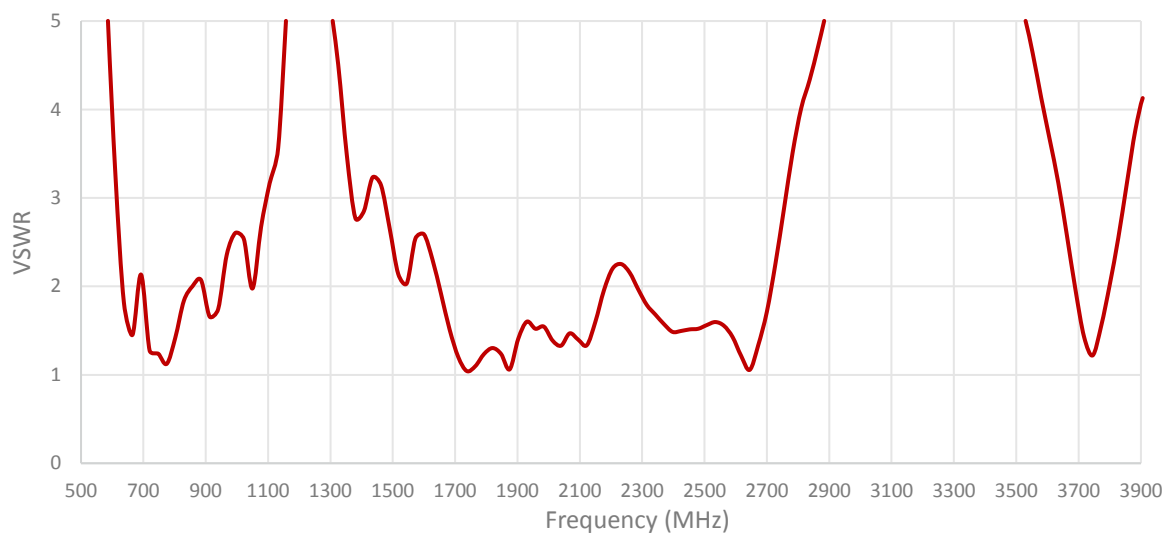
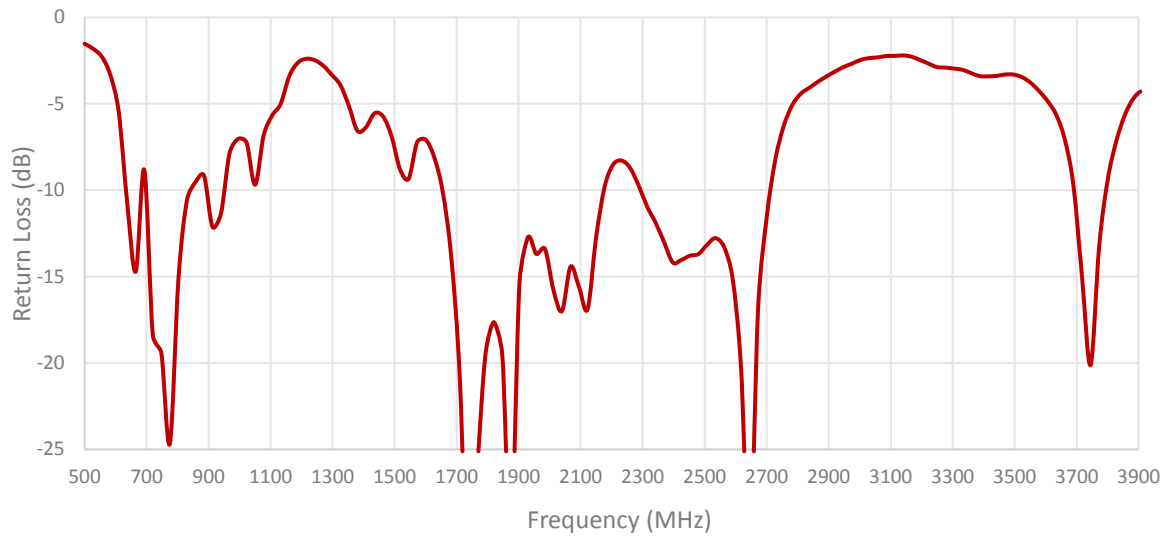

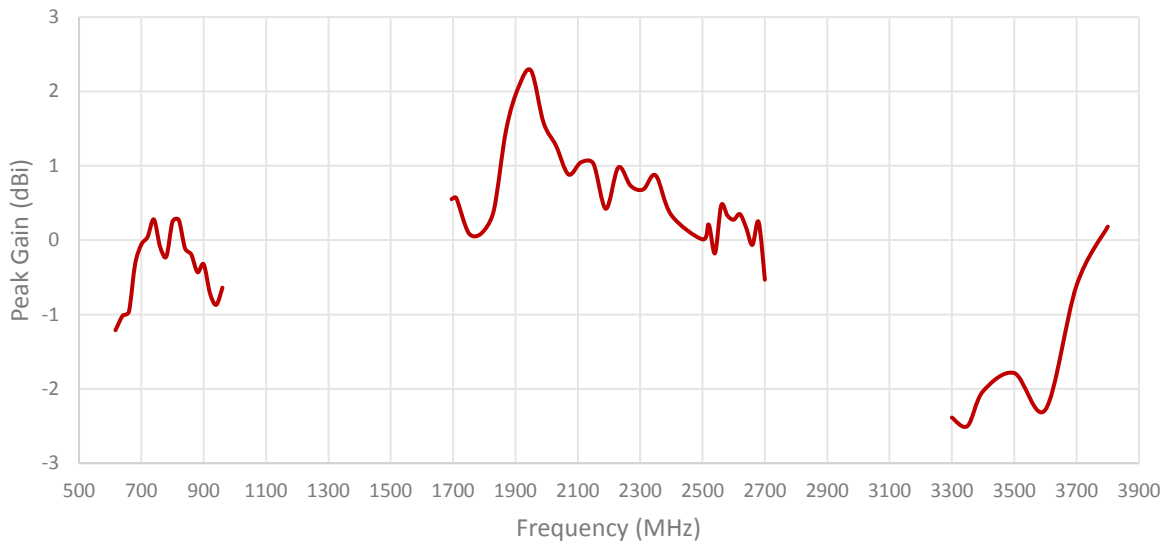
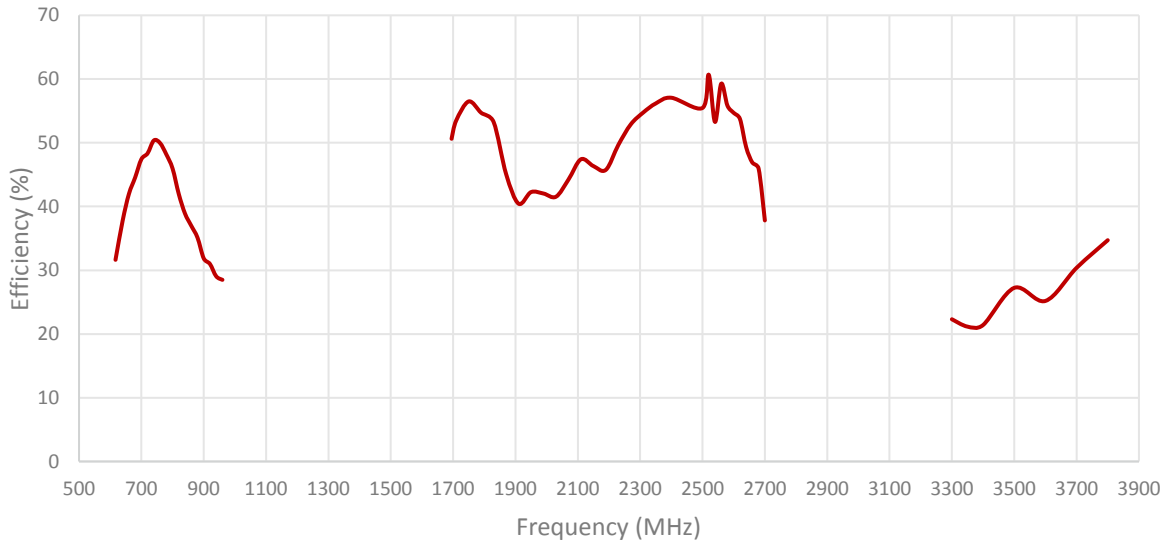

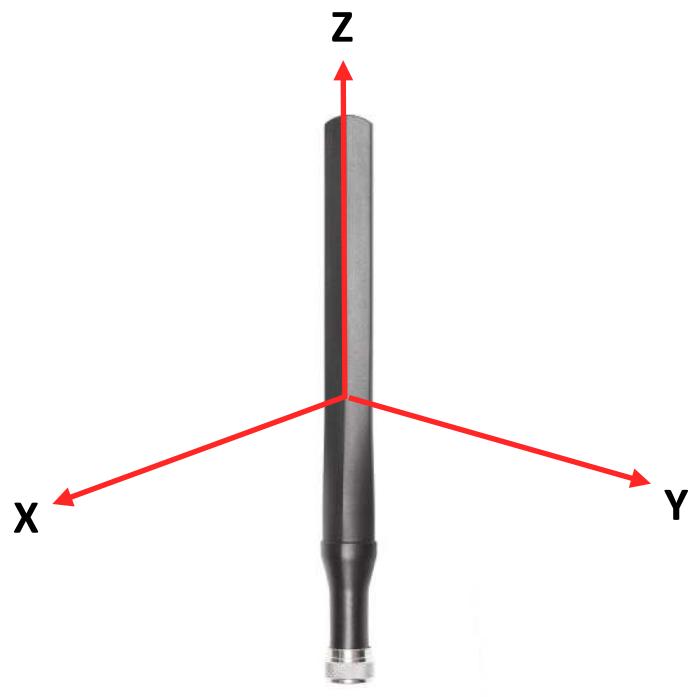
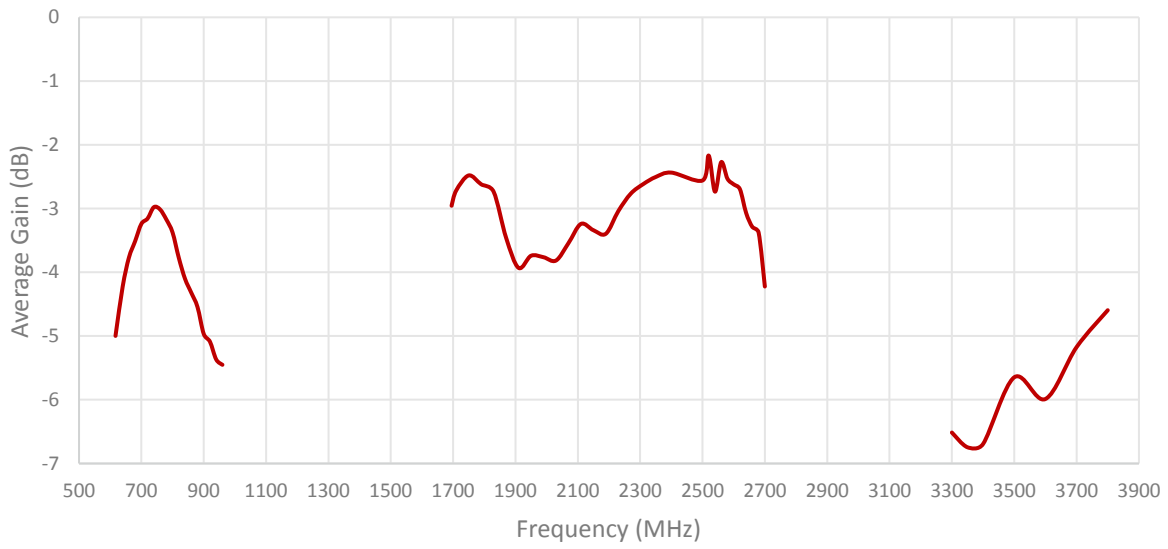

Radiation pattern reference

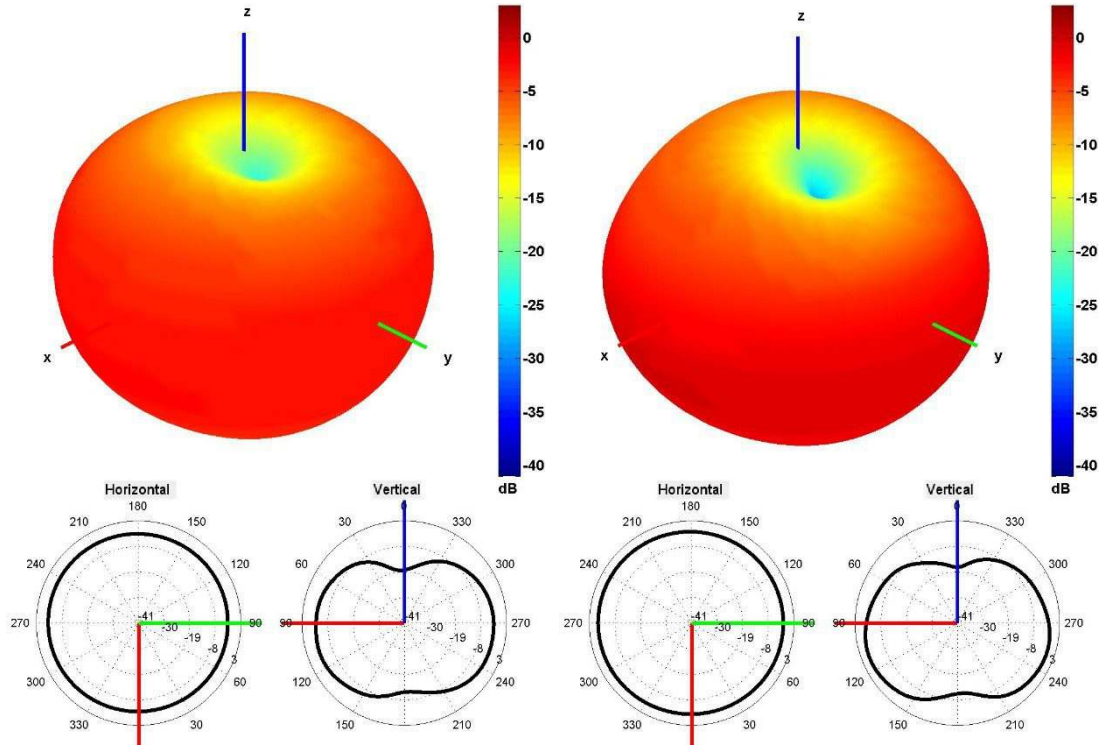

650 and 750 MHz Radiation pattern

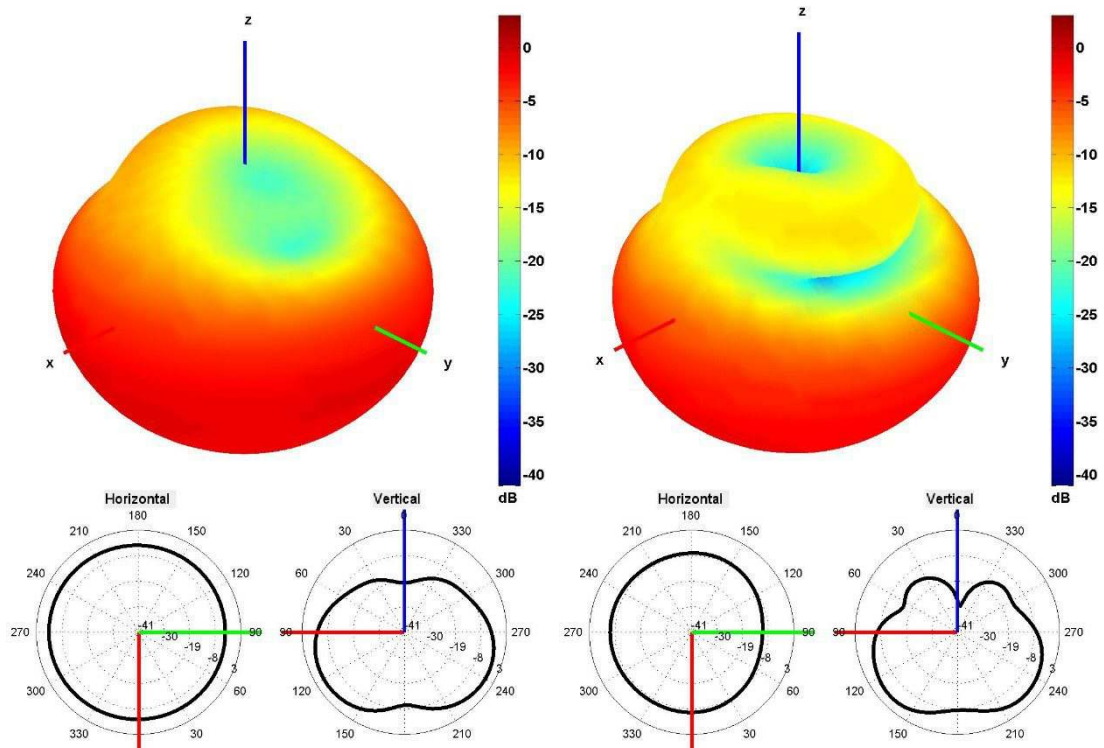

850 and 940 MHz Radiation pattern

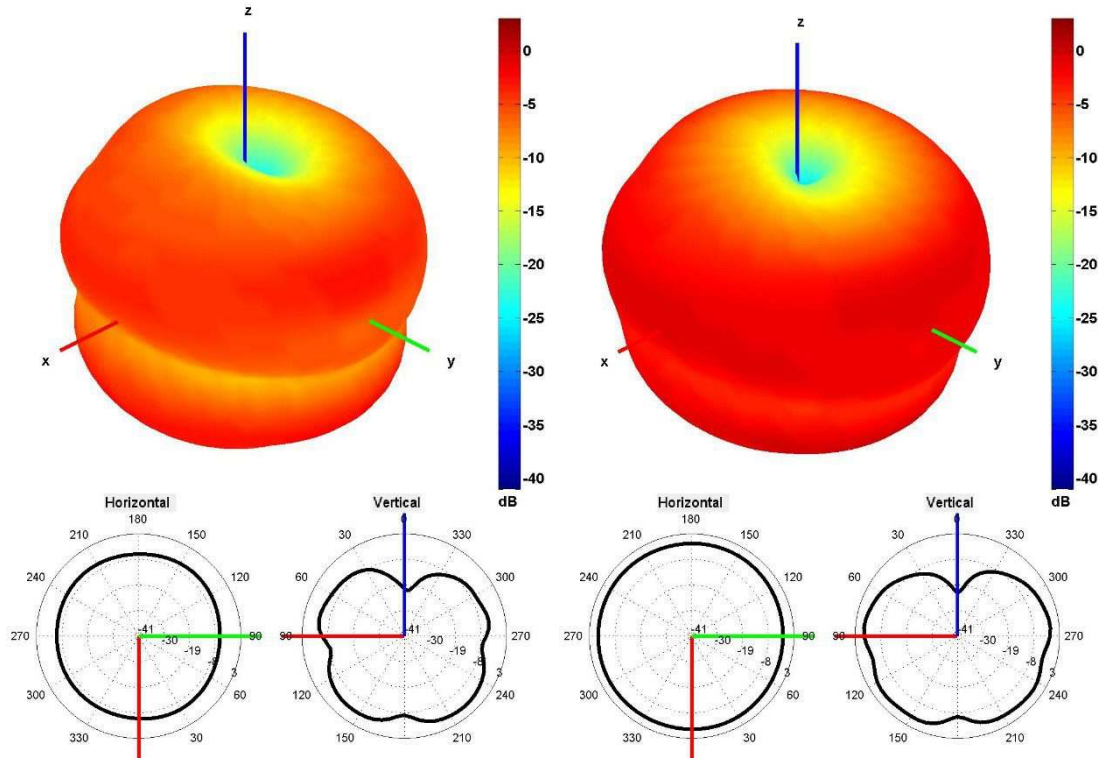

1500 and 1600 MHz Radiation pattern

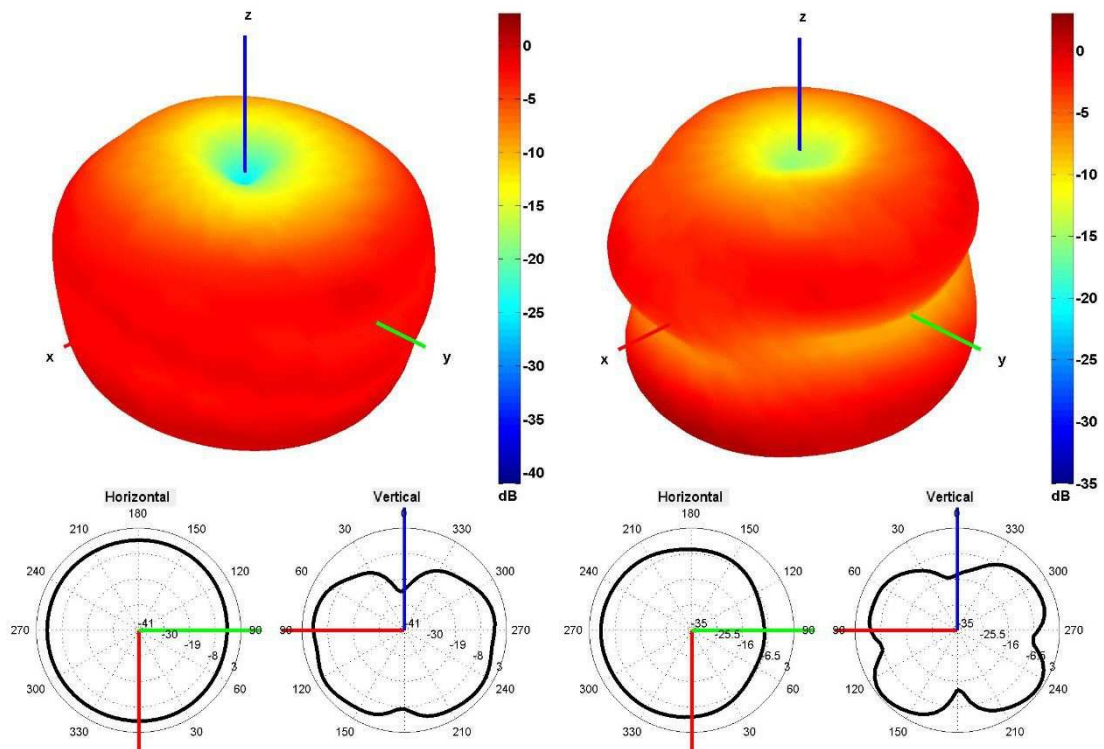

1750 and 1850 MHz Radiation pattern

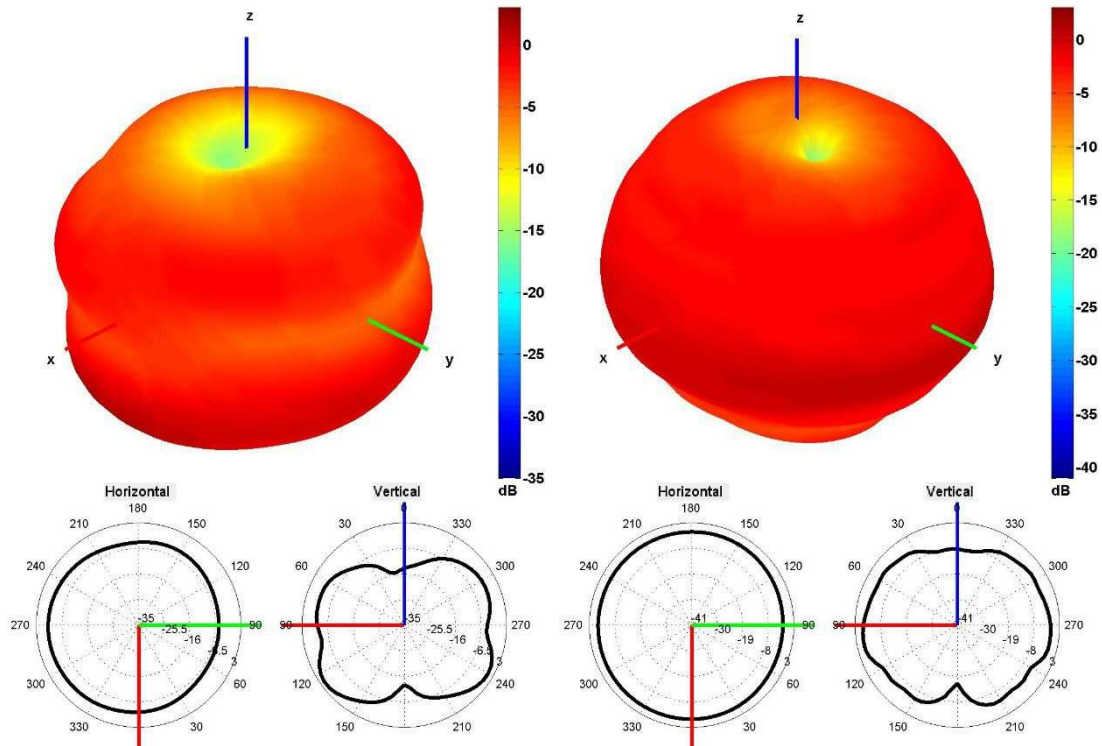

1950 and 2100 MHz Radiation pattern

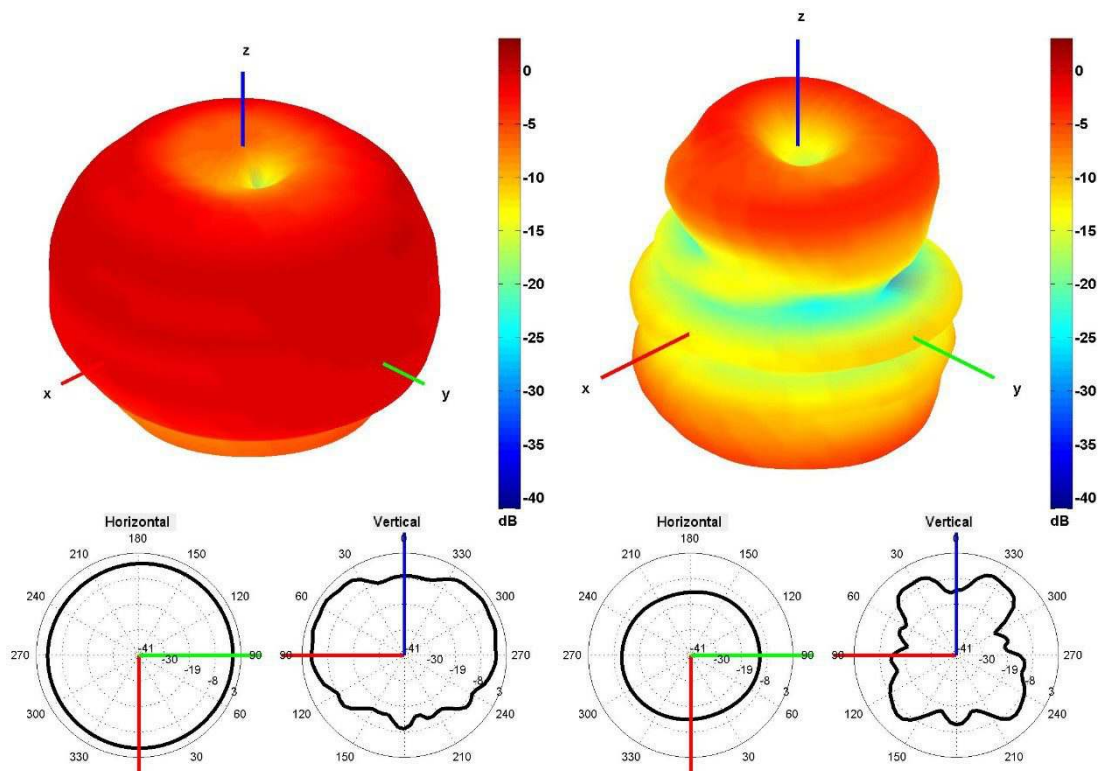

2350 and 2600 MHz Radiation pattern

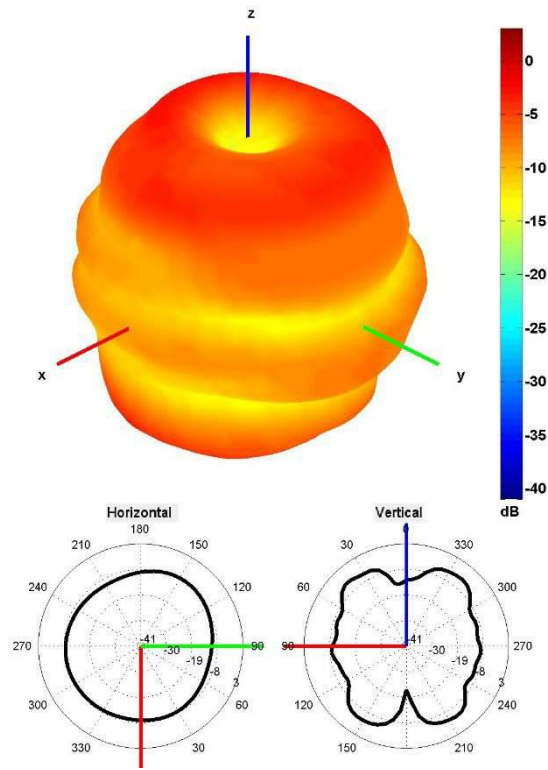

3600 MHz Radiation pattern

4. Antenna drawings

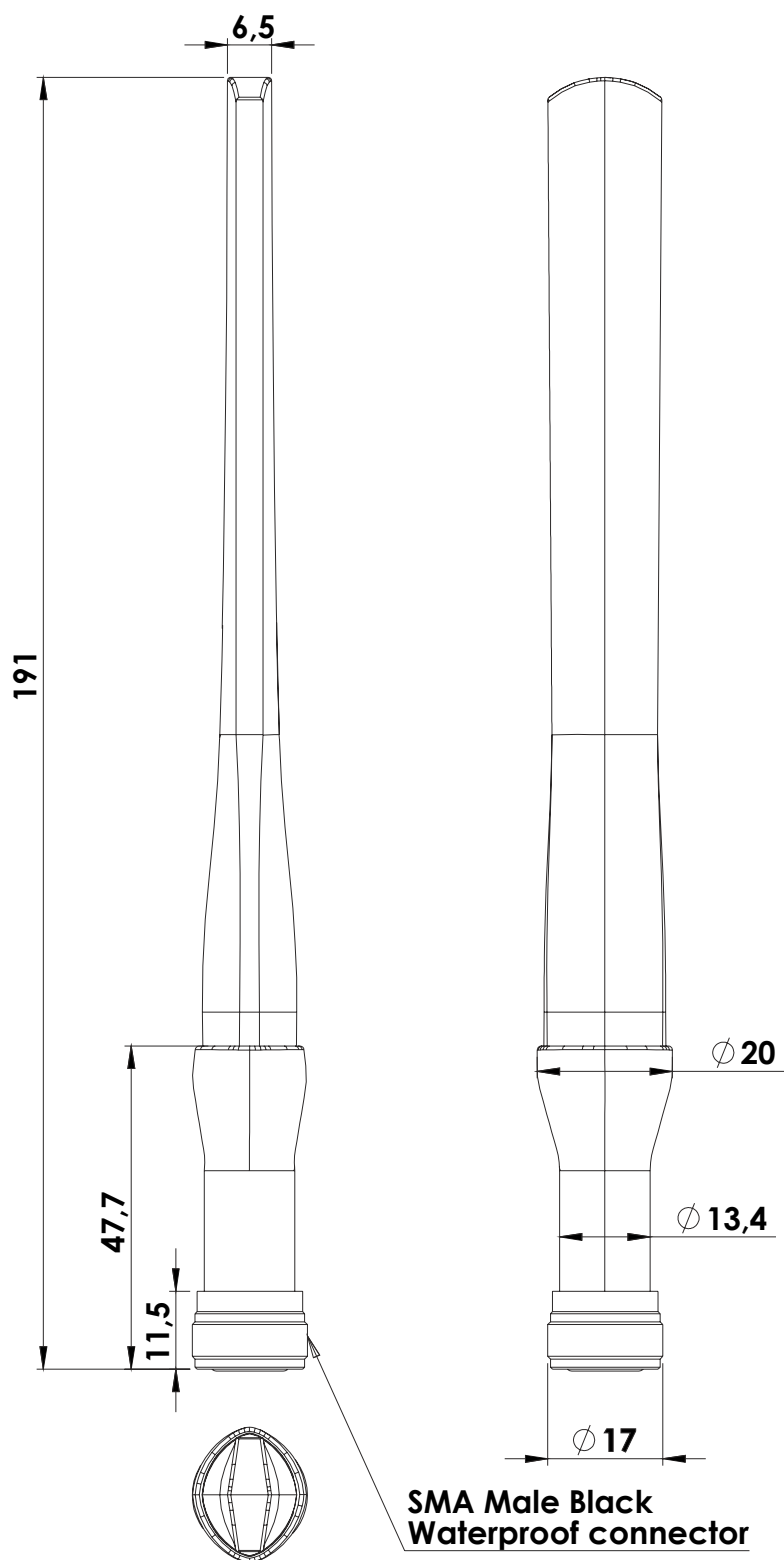

5. Antenna Images

